

# FUJITSU

# Halcyon

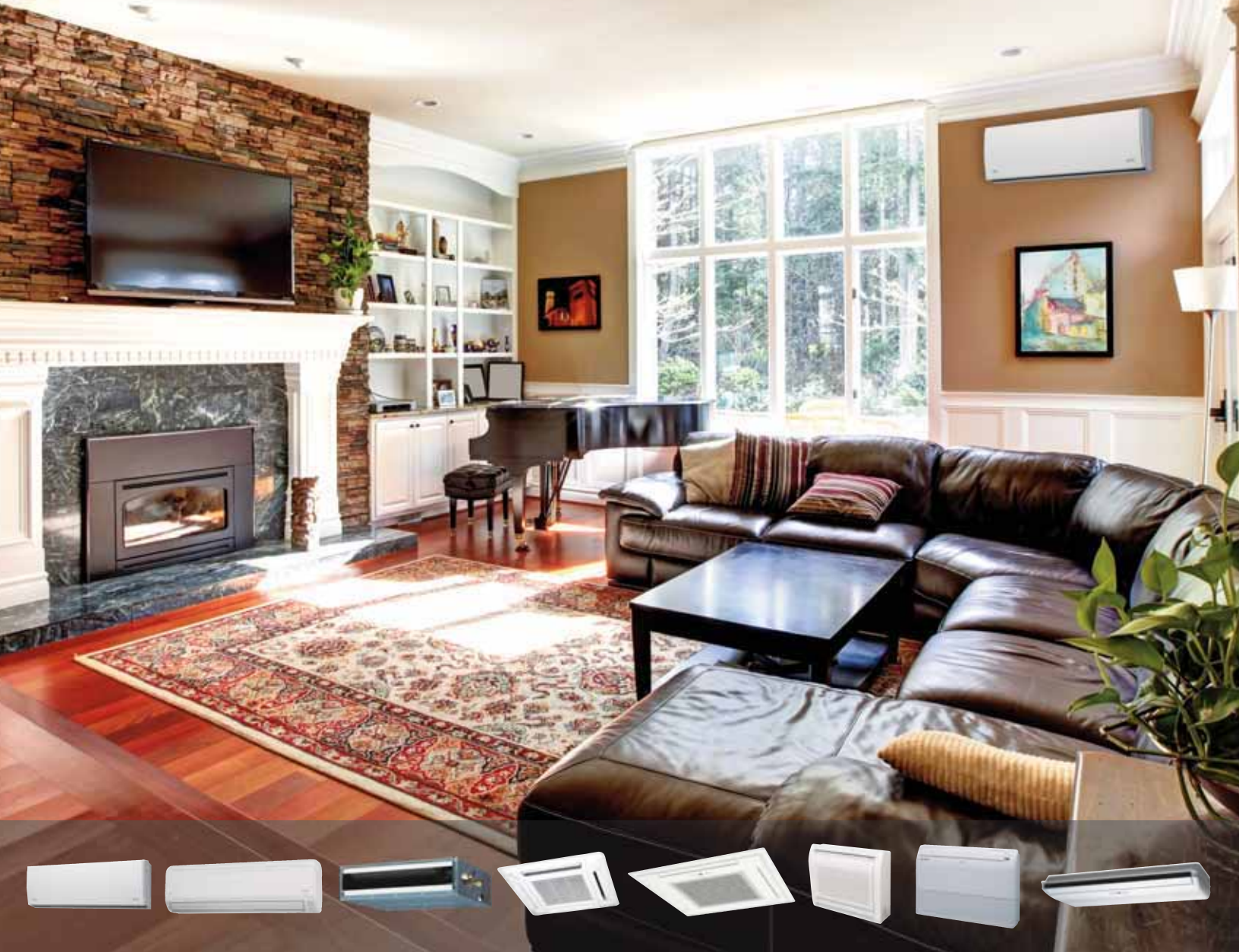

## Mini-Split Air Conditioners and Heat Pumps for Residential and Light Commercial Applications





Halcyon



*Where comfort and style meet  
performance and reliability.*



# TABLE OF CONTENTS

## FEATURES

Mini-Splits Defined.....	4
Individual Zoning .....	6
Comfort Solution .....	8
Energy Efficient .....	9
Comfort & Convenience .....	10
Applications .....	11
Feature Descriptions .....	12

## MODEL LINEUP

Indoor and Outdoor Model Table .....	14
--------------------------------------	----

## SINGLE ZONE MINI-SPLITS

Wall Mount .....	17
Floor/Ceiling .....	23
Ceiling Suspended .....	23
Floor Mount .....	24
Duct .....	26
Compact Cassette .....	28
Large Cassette .....	30

## MULTI-ZONE MINI-SPLITS

Overview .....	33
Indoor Units	
Wall Mount .....	35
Duct .....	36
Compact Cassette .....	37
Floor Mount .....	38
Multi-Zone (2-4 Zones) Outdoor .....	39
Flex-Zone (2-8 Zones) Outdoor .....	42
Branch Boxes .....	43
Wiring .....	44
Piping .....	45
Allowable Combinations .....	46

## ACCESSORIES

Descriptions .....	48
Compatibility Chart .....	49

## MISCELLANEOUS

Line Set Length Chart .....	50
Model Nomenclature .....	50



# Fujitsu Mini-Splits: Year-Round, Whole-Home or Business Energy Efficient Heating and Cooling

## What is a Mini-Split?

Halcyon systems eliminate the need for a basement or attic-located evaporator unit and bulky ductwork by using thin copper tubing that pumps refrigerant directly to discreet wall mounted or concealed units inside. Even more remarkable, this same unit works in reverse in winter, absorbing heat from the outside air and moving it indoors to heat your home. The result? Efficient cooling and heating for year-round, whole-house comfort in most climates.

Available in numerous mix-and-match capacities and configurations, there's a Halcyon mini-split system for even the most difficult to heat and cool areas.



## How Does a Mini-Split Work?

Like your refrigerator, heat pumps use electricity to pump refrigerant and transfer heat from one space to another. When we transfer heat from within our home to the outdoors, we call it "air conditioning". Conversely, when we transfer heat from the outdoors to within the home, we call it a "heat-pump".

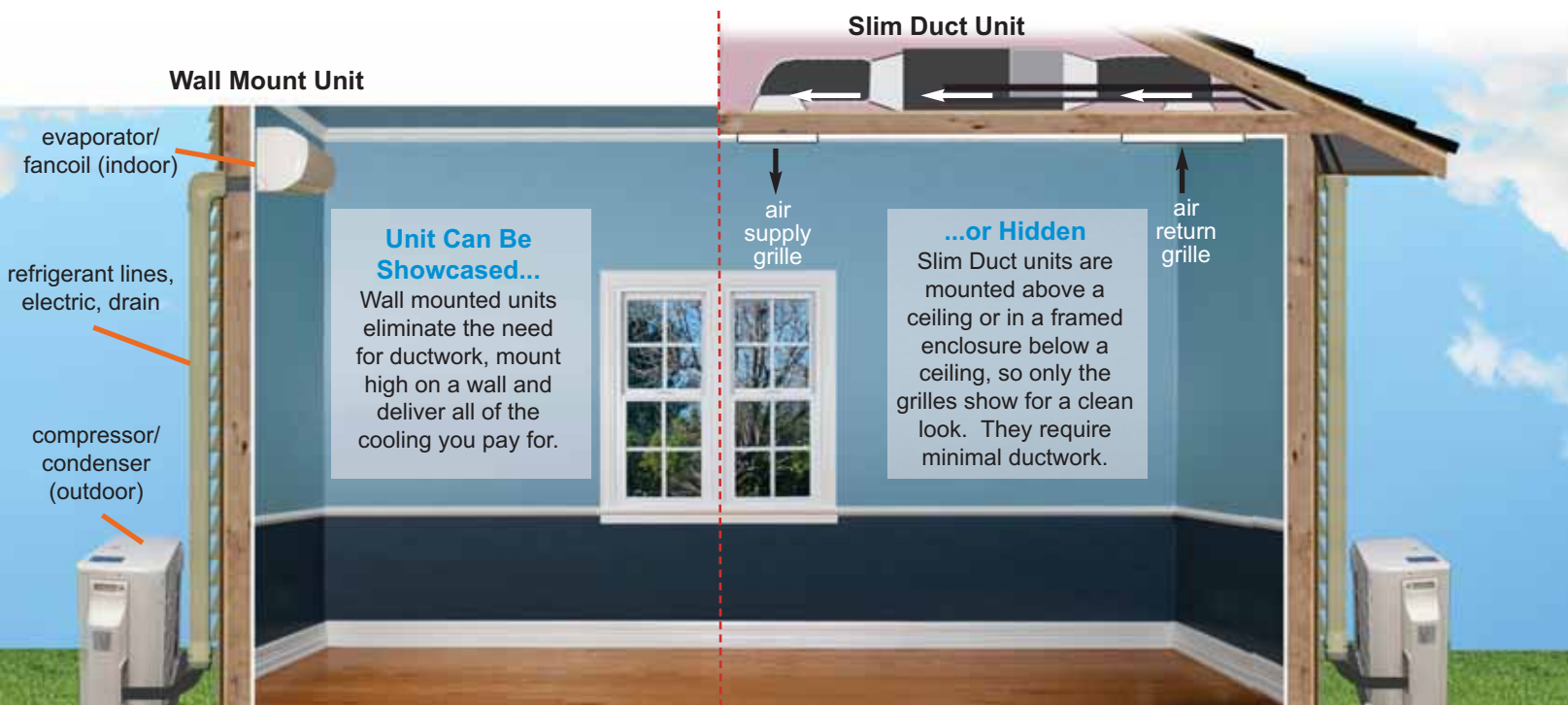

## Heat Pumps Provide Heat When it is Chilly

Because refrigerant is naturally much colder than outdoor temperatures even on a very cold day, it actually absorbs heat from outdoors, and transfers the heat it absorbs outside to within your home. The refrigerant's physical properties do this naturally. What you pay for is the electricity to pump refrigerant via copper tubing from outdoors to indoors. Because we move the heat rather than create it (as electric baseboard or resistant heat does), we can deliver up to 4 times the heat for the energy we consume!

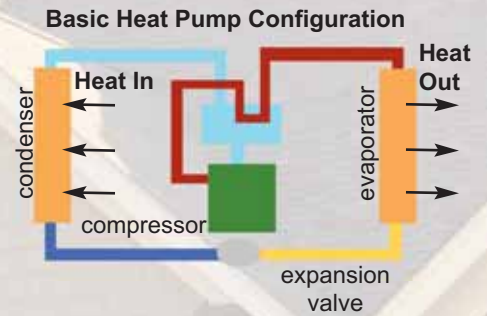

## Air Conditioners Provide Cooling When It's Warm

Come spring and summer, simply reverse the process and put the same system into "cooling mode" and transfer heat from indoors to the outside. For many climates, the advanced technology that goes into these units creates a far more cost effective alternative to either gas or oil-fired units for heat, or a central ducted system for air conditioning. Fujitsu's mini-splits come in both cooling-only models or heat pumps, which provide both heating and cooling.

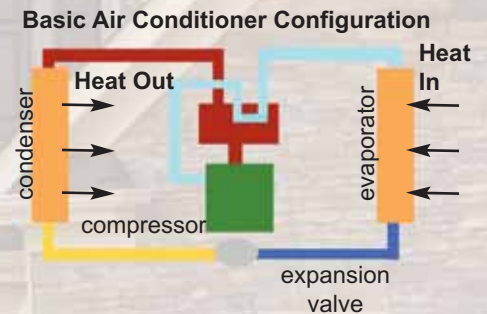

## Electric Heaters versus Heat Pumps



An electric heater converts electricity directly to heat, and if we assume that the heat loss is zero, the output from one kilowatt input is one kilowatt or 3,400 BTU and the EER is 3.4.



Heat pumps are more efficient than some other forms of heating because heat pumps do not actually create heat - they just move it from one place to another.

For example, the output of an efficient 10 EER heat pump is triple that of an electric heater.

\*EER (Energy Efficiency Rating) = Rated BTU capacity divided by total kW input.

# Individual Zoning: Personalized Whole Home Comfort

Halcyon HFI Systems are some of today's most advanced forms of heating and air conditioning. One outdoor unit can operate up to 8 indoor units simultaneously. Fujitsu's HFI Systems are super quiet as well as highly energy efficient.

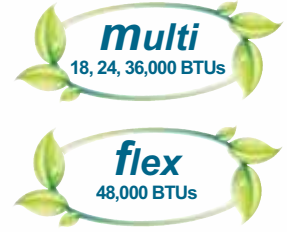

- Each indoor unit can be operated independently via remote control
- Choose from a variety of indoor unit styles
- Provide both heating and cooling (not simultaneously)
- High energy efficiencies
- Quiet operation

## Wall Mounted

They mount high on a wall, out of sight and do not require ductwork, increasing energy efficiency.

- Quiet operation
- Easy maintenance
- High delivered efficiency means lower utility bills

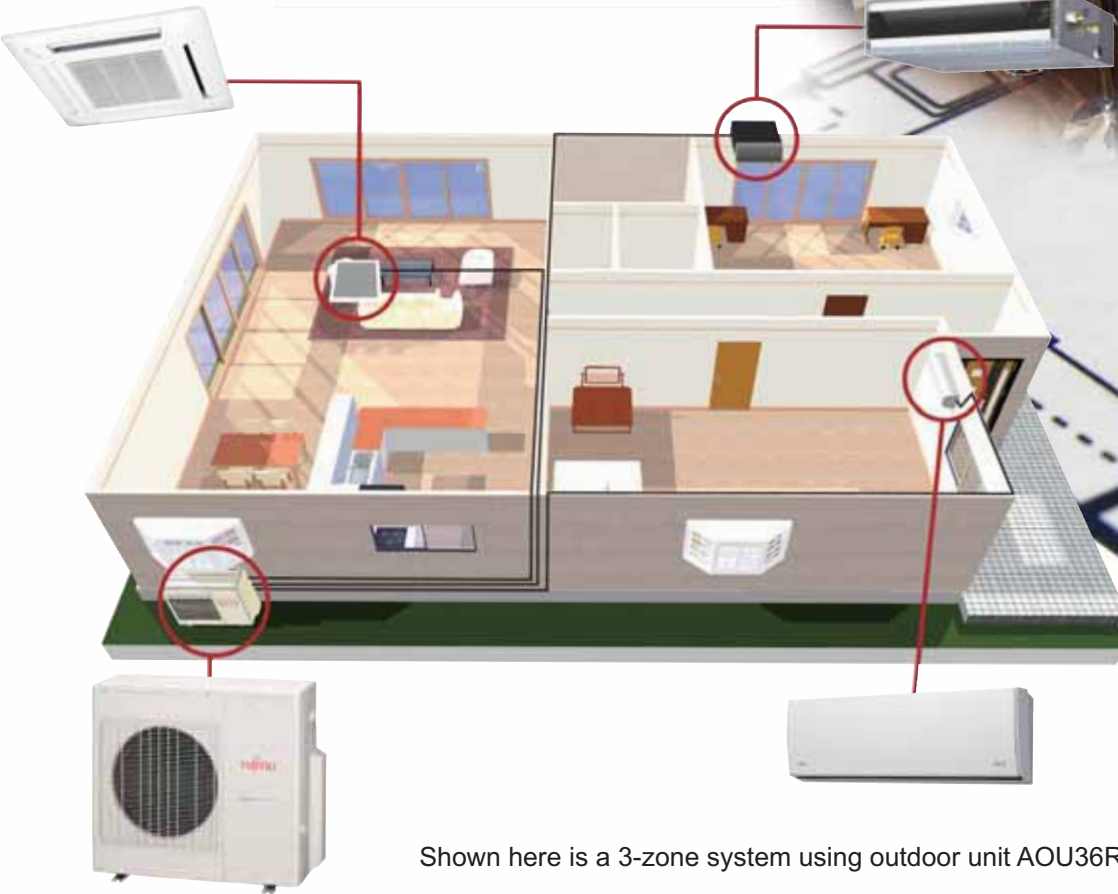

Shown here is a 3-zone system using outdoor unit AOU36RLXFZ.



## Slim Duct

Mounted in a ceiling or in a framed enclosure below a ceiling. They use minimal ductwork and remain very energy efficient.

- Concealed and out of sight
- Look of central air with the efficiency of a mini-split
- Less ducts = higher efficiency

## Floor Mounted

Floor mount systems are ideal for residential radiator replacements or any room with limited upper wall space, like a kitchen or sunroom.

- Compact size fits easily under a standard window
- Features twin airflow for improved heat delivery
- Designer wireless remote control

## Compact Cassette

Cassettes are extremely discreet, with only the grille showing in the ceiling. They use the latest fan technology to distribute the conditioned air evenly.

- Wired remote controller (wireless is optional)
- Powerful turbo fan operation
- Fits into a standard 2' x 2' ceiling grid

# A Solution for All of Your Comfort Needs

## Ductless Technology

Don't waste money cooling and heating the ducts in your walls and attic. Fujitsu systems are duct-less, meaning they install easily and won't take up valuable closet space. Since mini-splits have little to no ducting, they forego those energy losses typically associated with central forced-air systems. Duct losses in a central air system can easily account for more than 30% of energy consumption, especially if the ducts are not sealed tight or in an unconditioned space such as an attic or crawlspace.

Central Air System versus Fujitsu HFI Quad Zone

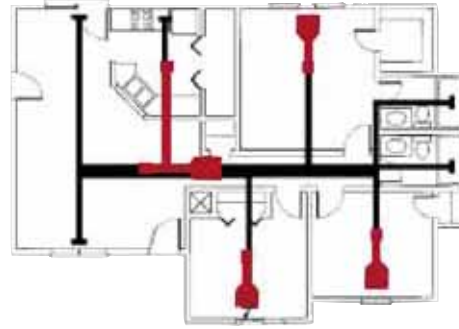

Thick black lines represent ducts of a Central Air System.

Red lines represent mini-ducts of a Fujitsu Quad Zone Slim Duct System.

## Whole Home or Business Comfort

Fujitsu's Halcyon HFI systems provide home and business owners just the right amount of heating and cooling needed by installing 2 to 8 indoor units connected to one outdoor unit. Indoor units vary by size and style and each creates its own "zone" of comfort, allowing you to heat or cool individual rooms, hallways and open spaces.



## A Year Round Solution

Revolutionary Halcyon heat pumps provide both heating and cooling for year round comfort in most climates. A simple push of a button on the remote control allows you to switch from heating to cooling (or vice versa) automatically.





# Energy Efficient: The Smart Choice in Comfort

As much as half of the energy used in your home goes to heating and cooling. So, making smart decisions about your home's heating and air conditioning system can have a big effect on your utility bills — and your comfort.

## Where Does My Money Go?



The high energy efficiencies of Halcyon systems slash utility bills by up to 25%. If your average annual utilities are \$4,200, Fujitsu can save you up to \$1,050 annually or \$10,500 in 10 yrs!\*

\*Savings may vary based on model selected, hours of operation and geographical location. Example given based on 26-SEER system versus 13-SEER system.

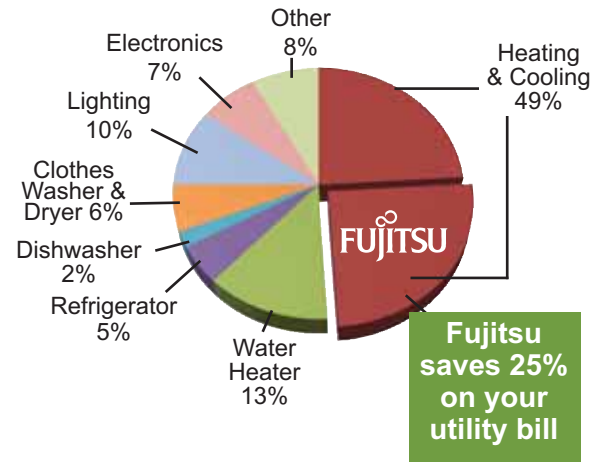

## Rebates

To encourage customers to buy energy efficient products, many local utility companies offer significant rebates for the purchase of a ductless mini-split system. Go to Fujitsu's web site to search for local rebates, consumer loans and utility bill discounts. We provide a listing of rebates and offerings on qualifying Fujitsu mini-splits by state. [www.fujitsugeneral.com/utility\\_rebates.htm](http://www.fujitsugeneral.com/utility_rebates.htm)



## ENERGY STAR® Qualified Systems

If your HVAC equipment is more than 10 years old or not keeping your house comfortable, you should have it looked at by a professional HVAC contractor. If it is not performing efficiently or needs upgrading, consider replacing it with a unit that has earned ENERGY STAR®. Installed correctly, these high-efficiency heating and cooling units can save up to 25 percent on heating and cooling costs.

Fujitsu has 25 systems that are ENERGY STAR qualified in 2014, 14 of which meet criteria qualifying for ENERGY STAR® Most Efficient. See the lineup chart on pages 14 - 15 for a full listing of all ENERGY STAR® qualified systems.



	SEER ≥ 14.5 EER ≥ 12.0 HSPF ≥ 8.2		SEER ≥ 20.0 EER ≥ 12.5 HSPF ≥ 9.6
-------------------------------------------------------------------------------------	-----------------------------------------	-------------------------------------------------------------------------------------	-----------------------------------------

# Comfort and Convenience

## Flexible and Quiet

Mini splits offer flexibility because they can be suspended from a ceiling, mounted flush behind a drop ceiling, hung on a wall or floor-standing. Ductless heat pumps allow for a peaceful inside environment by enabling the contractor to install components like compressors and motors outdoors.

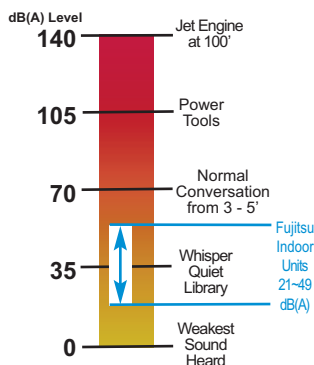

## Constant Comfort through Inverter Technology

Inverter technology is like cruise control for your heating or cooling system. Compressors only run as fast as they need to handle the cooling or heating demand. They can handle greater extremes in temperature, are smoother and more stable in operation, and reach the desired temperature more quickly than conventional air conditioners.

### Inverter Benefits

- More heat at lower outdoor temperatures
- Lower RPMs = quieter operation
- Desired temperature in half the time
- Up to 30% more efficient
- Stable temperature

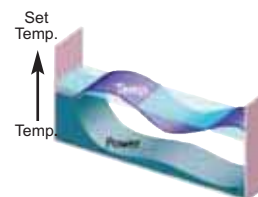
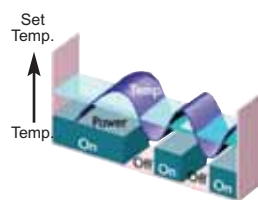

## User Friendly Control

Fujitsu is using ergonomics to expand the use of user friendly designs such as easy-to-read large LCD displays, easy-to-operate buttons, and displays with easily recognizable colors and icons. We are producing control systems that provide greater convenience for both individual and centralized control with operability suitable for the application.



Optional Wired Remote UTY-RVNUM

Standard Wireless Remote for select systems



# Applications



## Where can mini-splits be used?

- Convenience stores
- Fast food chains
- Fire houses
- Police stations
- Oil rigs
- Bars
- Sunrooms and additions
- Warehouses
- Nursing homes
- Small offices
- Older homes
- New construction homes
- Schools
- Places of worship
- Hospitals and medical facilities
- Restaurants
- Computer rooms
- Hotels and motels
- Car washes
- ATM vestibules

**Just about any place that requires comfort!**



# Feature Explanation

## SEER

Seasonal Energy Efficiency Rating. Used to express efficiency of an AC or Heat Pump. A higher rating means more efficient.

## HSPF

Heating Seasonal Performance Factor, measures the efficiency of heating portion of your heat pump.



## ENERGY STAR® Qualified

Qualified products and practices help you save money and reduce greenhouse gas emissions by meeting strict energy efficiency guidelines set by the U.S. Environmental Protection Agency and the U.S. Department of Energy.



## Apple Catechin Filter (polyphenol ingredient from apples)

Dust, mold spores and microorganisms are absorbed onto the filter by static electricity and growth is inhibited and deactivated. 3 - 12 month life expectancy, depending on environment.



## Ion Deodorizing Filter

Deodorizes by decomposing absorbed odors using the oxidizing and reducing effects of ions generated by fine ceramic particles. 3 year life expectancy. Wash to restore surface action.



## Sleep Timer

Automatically adjusts the temperature while you sleep to make you more comfortable.



## 24 Hour Timer

Allows for one on/off cycle during a 24 hour period.



## Weekly Timer

Allows you to set on/off time twice a day and a different on/off time by day.



## Dry Mode

Helps reduce humidity levels when cooling requirements are low.



## Auto Louver: Up/Down

Redirects airflow automatically with seven position up and down motion which can be set to auto swing.



## Auto Louver: 4 Way

Redirects airflow automatically with up/down and left/right motion.



## Auto Fan Mode

System starts in high fan speed and automatically adjusts downward as room begins to reach set temperature.



## Powerful Operation

20 minutes of continuous operation at maximum airflow and maximum compressor speed. Rapid cooling and heating makes the room comfortable quickly.



## Minimum Heat Mode

Sets room temperature to 50°F, keeping temperatures above freezing and reducing power consumption.



## Economy Mode

Thermostat setting automatically changes according to the temperature to avoid unnecessary cooling and heating.



## Energy Saver

Keeps room cool enough for comfort by using a relaxed thermostat setting reducing power consumption.



## Energy Saving Program (ESP)

If a space is left without turning the unit off, ESP knows that it is unoccupied and 20 minutes later, temperature is adjusted accordingly until users return to the room. Function is disable in multi-zone installations.

+Function is bypassed during defrost and at low speed operation. This feature may limit cooling/heating capacity during high/low ambient conditions and increase energy consumption as system may need to operate longer due to reduced compressor speed.



## Quiet Mode (Indoor Unit)

An extra quiet fan speed to make sure you are not disturbed.



## Outdoor Unit Low Noise

Limits compressor and fan speed during high speed operation for a 3 dB noise reduction.+



## Power Diffuser

An additional louver that opens based on monitoring sensors to quickly enhance immediate comfort needs.



## Auto Restart/Reset

Following a power failure, systems will automatically restart in the same operating mode as before, once power has been restored.



## Auto Changeover (heating to cooling or vice-versa)

Automatically alternates between heating or cooling if the room temperature falls 4°F below the set temperature when cooling or rises 4°F above set temperature when heating.\*



## Low Ambient Cooling

Can operate in cooling mode even when outdoor ambient is 0°F, 14°F or 32°F, depending on model, without modification. Operation outside of factory specification is not recommended.



## Cold Prevention

Indoor coil will warm prior to fan operating, preventing cold air during heating mode.



## Slender Fit

Cassette body can be moved downward into the room 1-3/8" to accommodate limited ceiling space.



## Remote Temperature Sensor

Room temperature sensor is located in optional wired remote controller only.



## Pump Down Operation

Collects all refrigerant in system back into the outdoor unit when the unit is to be moved or before servicing the refrigerant circuit.



## Daisy Chain

Ability to connect up to 16 identical style indoor units to one wired remote.



## High Ceiling Mode

Temperature at the top of a high ceiling room may be warmer than the space occupied; this mode adjusts for this difference.



## Branch Duct Capable

Systems are capable of attaching field-supplied branch ducts providing up to 38% of the cooling up to 16 feet away.



## Fresh Air Intake

Outside air can be introduced by attaching field supplied flexible duct to fresh air knockouts.



## Base Pan Heater

Prevents condensate from freezing on the outdoor unit.



## Third Party Device Control

Turns system on or off using a normally closed circuit. Interface with third party devices such as home automation.



## Warranty

Fujitsu systems come with either a 2 Year Parts / 6 Year Compressor warranty or a 5 Year Parts / 7 Year Compressor warranty.

\*Auto Changeover is not designed to provide rapid changes between heating and cooling operation or simultaneous heating and cooling. This feature is not recommended for systems with more than one indoor unit unless all indoor units have similar heating and cooling requirements and have similar temperature set points. If all indoor units have similar heating and cooling requirements and have similar temperature set points, auto changeover will work.







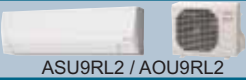

# Feature Summary

	Single Zone Wall Mount Heat Pumps	Single Zone Wall Mount Cooling	Single Zone Ducted	Single Zone Cassette	Universal/Ceiling Susp.	Floor Mount	Large Cassette	HFI Multi-Zone and Flex-Zone
	9RL2 11.0.23.0 9RLFW1 9RLS2 12.5.27.2 9RLS2H 8.8.27.2 9RLS2 9.0.16.0 12RL2 11.0.22.0 12RLFW1 12RLS2 12.0.25.0 12RLS2H 9.3.25.0 15RLS2 12.0.21.5 15RLS2H 10.3.21.5 15RLS2H 10.0.19.0 18RLXFW 10.0.18.0 24RLXFW 9.5.17.5 30RLX	18CL - 19.0 24CL1 - 17.5 30CL1 - 16.5 36CL1 - 15.5	9RLFCF 12.2.21.2 9RLFCF 11.5.20.0 12RLFCF 11.3.19.7 18RLFCF 9RLFCF 13.0.24.0 12RLFCF 12.2.21.9 18RLFCF 11.5.20.1	18RULX 8.5.16.0 24RULX 8.5.15.0 36RSLX 8.5.14.0 9RLFF 12.6.26.0 9RLFFH 12.4.26.0 9RLFFH 11.6.22.7 12RLFF 11.3.22.7 12RLFFH 11.2.20.3 15RLFF 11.0.20.3 15RLFFH	18RCLX 8.5.16.0 24RCLX 8.5.15.0 36RCLX 8.5.14.0 42RCLX 8.5.15.0	HFI: Small Wall (7, 9, 12k BTU) HFI: Designer Wall (9, 12, 15k BTU) HFI: Large Wall (18, 24k BTU) HFI: Cassette HFI: Slim Duct HFI: Floor Mount		
SEER	9.0 16.0	-	12.2 21.2	8.5 16.0	8.5 16.0	12.6 26.0	8.5 16.0	9.8* 17.0*
HSPF	12.5 27.2	-	11.3 19.7	8.5 15.0	8.5 14.0	12.4 26.0	8.5 15.0	9.8* 17.0*
ENERGY STAR® Qualified	●		●			●		●
Apple Catechin Filter	●	●				●		●
Ion Deodorizing Filter	●	●				●		●
Sleep Timer	●	●			●	●		●
24 Hour Timer	●	●			●	●		●
Weekly Timer	□	□	□	□	□	□	□	□
Dry Mode	●	●			●	●		●
Auto Louver: Up/ Down	●	●			●	●		●
Auto Louver: 4 Way		●			●	●		●
Auto Fan Mode	●	●			●	●		●
Powerful Operation	●	●			●	●		●
Minimum Heat Mode	●	●	▲	▲	▲	●		▲
Economy Mode	●	●	●	●	●	●		●
Energy Saver	●	●			□	●	●	●
Energy Saving Program	●	●					●	●
Quiet Mode (Indoor Unit)	●	●				●		●
Outdoor Unit Low Noise	●	●				●		●
Power Diffuser	●	●				●		●
Auto Restart/Reset	●	●			●	●		●
Auto Changeover	●	●			●	●		●
Low Ambient Cooling	●	●			●	●		●
0-Degree Ambient Cooling		●			●	●		●
Long Piping Length (165'+)		●			●	●	★	★
Cold Prevention	●	●			●	●		●
Slender Fit						●		
Remote Temperature Sensor	□	□	□	□	□	□	□	□
Daisy Chain						●		●
Pump Down Operation		●			●	●		●
High Ceiling Mode					●	●		●
Branch Duct Capable					●	●		●
Condensate Pump					●	●		●
Fresh Air Intake					◆	◆		◆
Base Pan Heater	●	●			●	●		●
Third Party Device Control**	○	○	○	○	○	○	○	○
Warranty: 6 Yr Compressor / 2 Yr Parts	7/5	7/5	7/5	7/5	7/5	7/5	7/5	7/5
Warranty: 7 Yr Compressor / 5 Yr Parts	7/5	7/5	7/5	7/5	7/5	7/5	7/5	7/5

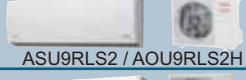
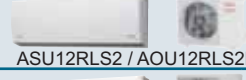
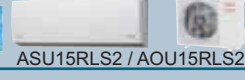
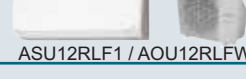



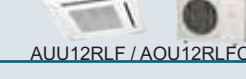

▲ SEER and HSPF ratings depend on combination of indoor units and outdoor unit selected.  
 □ Available only with optional wired remote controller.      □\* Available only with optional wired remote controller and optional Interface Kit.  
 ▲ Available only with optional wireless remote controller.      ○ Available only with optional Interface Kit.  
 ◆ Available only with optional Fresh Air Intake Kit.      ★ Available only when used with Flex Zone AOU48RLXFZ1 outdoor unit.  
 \* The only combinations that qualify are AOU18RLXFZ with (2) ASU9RLF1, AOU18RLXFZ with (1) ASU7RLF1 + (1) ASU12RLF1, AOU18RLXFZ with (1) ASU9RLF1 + (1) ASU12RLF1, AOU24RLXFZ with (2) ASU7RLF1 + (1) ASU9RLF1.  
 \*\* Operation monitoring and On/Off control only.  
 + Auto Changeover is not designed to provide rapid changes between heating and cooling operation or simultaneous heating and cooling. This feature is not recommended for systems with more than one indoor unit unless all indoor units have similar heating and cooling requirements and have similar temperature set points. If all indoor units have similar heating and cooling requirements and have similar temperature set points, auto changeover will work.

# Single Zone And Multi-Zone Systems Lineup

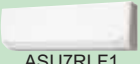
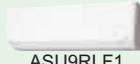
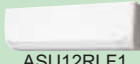
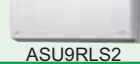
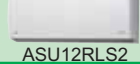
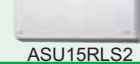
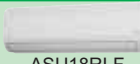
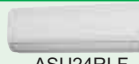
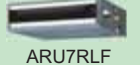
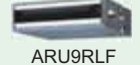
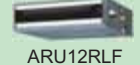
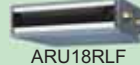
## SINGLE ZONE MINI-SPLITS

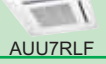
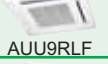
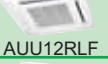
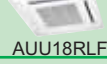

BTU	9,000	12,000	15,000
<b>Wall Mount</b> 115V Inverter	 ASU9RL2 / AOU9RL2	 ASU12RL2 / AOU12RL2	
<b>Wall Mount</b> High SEER	 ASU9RLS2 / AOU9RLS2	 ASU12RLS2 / AOU12RLS2	 ASU15RLS2 / AOU15RLS2
<b>Wall Mount</b> Extra Low Temp Heating	 ASU9RLS2 / AOU9RLS2H	 ASU12RLS2 / AOU12RLS2H	 ASU15RLS2 / AOU15RLS2H
<b>Wall Mount</b> Heat Pump	 ASU9RLF1 / AOU9RLF1	 ASU12RLF1 / AOU12RLF1	
<b>Wall Mount</b> Cooling Only			
<b>Universal Mount</b> Floor/Ceiling			
<b>Ceiling Suspended</b>			
<b>Floor Mount</b>	 AGU9RLF / AOU9RLFF	 AGU12RLF / AOU12RLFF	 AGU15RLF / AOU15RLFF
<b>Floor Mount</b> Extra Low Temp Heating	 AGU9RLF / AOU9RLFFH	 AGU12RLF / AOU12RLFFH	 AGU15RLF / AOU15RLFFH
<b>Slim Duct</b>	 ARU9RLF / AOU9RLFC	 ARU12RLF / AOU12RLFC	
<b>Compact Cassette</b>	 AUU9RLF / AOU9RLFC	 AUU12RLF / AOU12RLFC	
<b>Large Cassette</b>			

## MULTI ZONE MINI-SPLITS - INDOOR UNITS

BTU	7,000	9,000	12,000	15,000	18,000	24,000
<b>Compact Wall Mount</b>	 ASU7RLF1	 ASU9RLF1	 ASU12RLF1			
<b>Designer Series Wall Mount</b>		 ASU9RLS2	 ASU12RLS2	 ASU15RLS2		
<b>Large Wall Mount</b>					 ASU18RLF	 ASU24RLF
<b>Slim Duct</b>	 ARU7RLF	 ARU9RLF	 ARU12RLF		 ARU18RLF	 ARU24RLF
<b>Compact Cassette</b>	 AUU7RLF	 AUU9RLF	 AUU12RLF		 AUU18RLF	
<b>Floor Mount</b>		 AGU9RLF	 AGU12RLF	 AGU15RLF		

	18,000	24,000	30,000	36,000	42,000
					
					
					
					
					
					

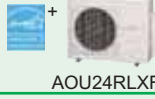
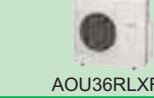
### MULTI ZONE MINI-SPLITS - OUTDOOR UNITS

BTU	18,000	24,000	36,000	48,000
<b>2 Indoor Units</b>				
<b>2 - 3 Indoor Units</b>				
<b>2* - 4 Indoor Units</b>				
<b>2 - 8 Indoor Units</b>				

\* If AOU36RLXFZ is paired with two 18,000 BTU indoor units, you have to purchase optional kit Part #K9FZ1818.

+ The only combinations that qualify are AOU18RLXFZ with (2) ASU9RLF1, AOU18RLXFZ with (1) ASU7RLF1 + (1) ASU12RLF1, AOU18RLXFZ with (1) ASU9RLF1 + (1) ASU12RLF1, AOU24RLXFZ with (2) ASU7RLF1 + (1) ASU9RLF1.

## SINGLE ZONE MINI-SPLIT SYSTEMS

*Making the hottest places  
cool and the coolest places  
more comfortable*

- Extensive lineup from 9,000 to 42,000 BTU/h
- 36 different systems available in 11 indoor unit styles
- Energy efficient systems with SEER ratings as high as 27.2 and HSPF as high as 13.0
- 21 ENERGY STAR® qualified systems
- Inverter Technology is used in all systems
- All systems feature environmentally friendly R410A refrigerant
- Quiet operation with indoor units as low as 21 dB and outdoor units as low as 47 dB





# Wall Mounted 115V Inverter 9, and 12,000 BTU Systems

## SYSTEMS 9RL2, 12RL2



**16.0 SEER**

### Function

Stylish, slim and elegant, these popular wall mounted units are designed for single rooms. Indoor units have a clean, aesthetic design and are small but mighty and shorter in length than competing units, helping them blend into any room. These 16-SEER heat pump systems now feature Inverter technology, environmentally friendly R410A refrigerant, both heating and cooling operation, quiet mode and easy maintenance.

### Applications

This category of equipment is ideal for smaller spaces where spot cooling or heating is required. Residential applications including sunrooms and additions are made easier with these 115 volt heat pumps. Do you have a warm or cool spot in your home? Fujitsu mini-splits can provide extra cooling or heating capacity for those hard to cool areas. Commercially, their small size makes them ideal for small offices, providing individual temperature control.

### Easy Maintenance

Front panel is easily removed for cleaning.



### Standard Features

- Wireless Remote Control
- Sleep Timer
- Dry Mode
- Auto Louver
- Auto Mode
- Powerful Operation
- Quiet Mode
- Economy Mode
- Auto Restart/Reset
- Auto Changeover
- Low Ambient
- Cold Prevention



	9RL2 Heat Pump	12RL2 Heat Pump
Nominal Cooling BTU/h	9,000	12,000
Nominal Heating BTU/h	10,000	14,000
HSPF BTU/hW	9.0	9.0
SEER BTU/hW	16.0	16.0
EER Clg/Htg	10.8/13.0	10.0/11.5
Clg. Operating Range °F(°C)	15~115 (-10~46)	15~115 (-10~46)
Htg. Operating Range °F(°C)	15~75 (-10~24)	15~75 (-10~24)
Moisture Removal Pt./h(l/h)	1.3 (2.7)	1.8 (3.8)
Voltage/Frequency/Phase	115/60/1	115/60/1
MAX.CRT.BKR (A)	15	20
Air Circ. C.F.M. (m <sup>3</sup> /h): Hi	436 (740)	436 (740)
Medium	353 (600)	353 (600)
Low	265 (450)	265 (450)
Quiet	191 (325)	191 (325)
Noise Level dB(A) Clg/Htg: Hi	43/43	43/43
Medium	38/38	38/38
Low	33/33	33/33
Quiet	23/23	23/23
Outdoor Fan Speed RPM	730	860
Outdoor Noise Level dB(A) Clg/Htg	47/48	51/51
Current (A): Cooling	7.5	10.9
Heating	7.0	11.0
Power Use (kw): Cooling	0.83	1.20
Heating	0.77	1.21
Fan Speeds Stage	4 + Auto	4 + Auto
Air Direction: Horizontal	Manual	Manual
Vertical	Automatic	Automatic
Air Filter	Washable	Washable
Connection Method	Flare	Flare
Combined Min. Lgth Ft (m)	10 (3)	10 (3)
Combined Max. Lgth Ft (m)	66 (20) (pre-charge: 49')	66 (20) (pre-charge: 49')
Max. Vertical Diff. Ft (m)	49 (15)	49 (15)
Conn. Pipe Diameter Inch	Suc. 3/8 Dis. 1/4	Suc. 3/8 Dis. 1/4
Net Weight lbs. (kg)	16 (7)	64 (29)
Dimensions: Height Inch	10-5/16	21-1/4
mm	262	540
Width Inch	32-9/32	26
mm	820	660
Depth Inch	8-1/8	11-11/32
mm	206	290
Refrigerant	R410A	R410A

Note: Figures are based on 115 Volts.

Indoor ASU9RL2  
Outdoor AOU9RL2  
Indoor ASU12RL2  
Outdoor AOU12RL2



# Wall Mounted High-SEER 9, 12 and 15,000 BTU Systems

## SYSTEMS 9RLS2, 12RLS2, 15RLS2



**Up to 27.2 SEER**

### ESP Energy Saving Program

These Halcyon systems know how to save you money even when you forget. If you leave the room without turning the unit off, ESP knows that you left and 20 minutes later, set temperature is increased by 4°F when cooling and reduced by 8°F when heating. When you come back to the room, it returns to previous operating mode. This prevents wasteful operation to save energy without you having to think about it. This feature can be deactivated if chosen.



### High Performance Heating

Heating capacity at low outdoor temperatures was improved by adopting a large heat exchanger and a high capacity compressor. Rated heating capacity is maintained down to 20°F. This new model can operate down to -5°F.

### Standard Features for RLS2 and RLS2H Models

- |                          |                           |
|--------------------------|---------------------------|
| Wireless Remote Control  | Economy Mode              |
| Apple Catechin Filter    | Energy Saving Program     |
| Ion Deodorizing Filter   | Quiet Mode (Indoor)       |
| Sleep Timer              | Low Noise Mode            |
| 24 Hour Timer            | Auto Restart/Reset        |
| Weekly Timer             | Auto Changeover           |
| Dry Mode                 | Low Ambient Cooling       |
| Auto Louver: Up/Down     | Cold Prevention           |
| Auto Mode                | Remote Temp. Sensor*      |
| Powerful Operation Mode  | 3rd Party Device Control* |
| Minimum Heat (50°F/10°C) |                           |

\* Available only with optional wired remote controller and optional interface kit.  
+ Available only with optional interface kit. Operation monitoring and On/Off control only.

### Optional Accessories

- Wired Remote Controller: UTY-RVNUM  
*Backlit and includes room temperature*
- Wired Remote Controller: UTY-RNNUM
- Simple Remote Controller: UTY-RSNUM
- Communication Kit: UTY-TWBXF



	9RLS2 Heat Pump	12RLS2 Heat Pump	15RLS2 Heat Pump
Nominal Cooling BTU/h	9,000	12,000	14,500
Min.~Max. Cooling BTU/h	3,100~12,000	3,100~13,600	3,100~18,400
Nominal Heating BTU/h	12,000	16,000	18,000
Min.~Max. Heating BTU/h	3,100~22,000	3,100~22,100	3,100~23,900
HSPF BTU/hW	12.5	12.0	12.0
SEER BTU/hW	27.2	25.0	21.5
EER Clg/Htg	16.1/15.0	13.8/13.3	12.0/13.3
Clg. Operating Range °F(°C)	14~115 (-10~46)	14~115 (-10~46)	14~115 (-10~46)
Htg. Operating Range °F(°C)	-5~75 (-21~24)	-5~75 (-21~24)	-5~75 (-21~24)
Moisture Removal Pt./h(W/h)	2.75 (1.3)	3.8 (1.8)	4.44 (2.1)
Voltage/Frequency/Phase	208-230/60/1	208-230/60/1	208-230/60/1
MAX.CRT.BKR (A)	20	20	20
Air Circ. C.F.M. (m <sup>3</sup> /h): Hi	500 (850)	500 (850)	530 (900)
Medium	394 (670)	394 (670)	436 (740)
Low	324 (550)	324 (550)	336 (570)
Quiet	194 (330)	194 (330)	229 (390)
Noise Level dB(A): Hi	43/43	43/43	45/45
Medium	37/38	37/38	40/40
Low	32/32	32/32	33/34
Quiet	21/21	21/21	25/27
Outdoor Fan Speed RPM Clg/Htg	780/780	870/780	870/780
Outdoor Noise Level dB(A)	48/49	49/50	51/51
Current Rated (A): Cooling	2.7	4.0	5.5
Heating	3.7	5.5	6.1
Power Use Rated (kw): Cooling	.56	.87	1.21
Heating	.80	1.20	1.35
Fan Speeds Stage	4+Auto	4+Auto	4+Auto
Air Direction: Horizontal	Manual	Manual	Manual
Vertical	Auto	Auto	Auto
Air Filter	Washable	Washable	Washable
Apple Catechin Filter	Yes	Yes	Yes
Connection Method	Flare	Flare	Flare
Combined Min. Lgth Ft (m)	10 (3)	10 (3)	10 (3)
Combined Max. Lgth Ft (m)	66 (20) (pre-charge: 49')	66 (20) (pre-charge: 49')	66 (20) (pre-charge: 49')
Max. Vertical Diff. Ft (m)	49 (15)	49 (15)	49 (15)
Conn. Pipe Diameter Inch	Suc. 3/8 Dis. 1/4	Suc. 3/8 Dis. 1/4	Suc. 1/2 Dis. 1/4
Net Weight lbs. (kg)	21 (9.5)	88 (40)	21 (9.5)
Dimensions: Height Inch	11-1/8 13-1/4*	24-13/32	11-1/8 13-1/4*
mm	282/337*	620	282/337*
Width Inch	34-1/4	31-3/32	34-1/4
mm	870	790	870
Depth Inch	7-1/4	11-13/32	7-1/4
mm	185	290	185
Refrigerant	R410A	R410A	R410A
Indoor ASU9RLS2	Indoor ASU12RLS2	Indoor ASU15RLS2	
Outdoor AO9RLS2	Outdoor AO12RLS2	Outdoor AO15RLS2	

Note: Figures are based on 230 Volts. \*Height when front panel is open.

# Wall Mounted High-Heat 9, 12 and 15,000 BTU Systems

## SYSTEMS 9RLS2H, 12RLS2H, 15RLS2H



Up to 27.2 SEER

### ESP Energy Saving Program

ESP senses when you leave a room and 20 minutes later, set temperature is increased by 4°F when cooling and reduced by 8°F when heating. When you come back to the room, it returns to previous operating mode. This feature can be deactivated if chosen.

### High Performance Heating

Heating capacity at low outdoor temperatures was improved by adopting a large heat exchanger and a high capacity compressor. Standard rated heating capacity is maintained down to 3°F. RLS2H models will deliver more than 73% of rated heating capacity at -15°F.

### Base Pan Heater

- Equipped with a base heater that prevents condensate from freezing
- Cultivated base design discharges melted water through many holes.
- Without a heater, freezing condensate can cause noise, damage to fan blade, condenser, and system performance

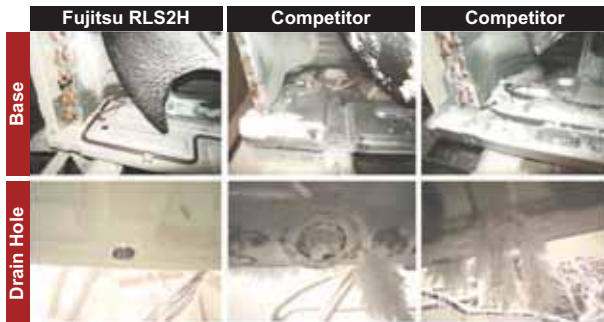

Drain hole is not filled, no freezing of base | Freezing where there is no heater | Drain hole is closed, large freezing of base

Condition: Indoor temp. of 68°FDB / outdoor temp. of 5°FDB, Heating mode, High airflow volume. Operation for 24 hours.

### Optional Accessories

- Wired Remote Controller: UTY-RVNUM  
Backlit and includes room temperature!
- Wired Remote Controller: UTY-RNNUM
- Simple Remote Controller: UTY-RSNUM
- Communication Kit: UTY-TWBXF



	9RLS2H Heat Pump	12RLS2H Heat Pump	15RLS2H Heat Pump
Nominal Cooling BTU/h	9,000	12,000	14,500
Min.~Max. Cooling BTU/h	3,100~12,000	3,100~13,600	3,100~18,400
Nominal Heating BTU/h	12,000	16,000	18,000
Min.~Max. Heating BTU/h	3,100~22,000	3,100~22,100	3,100~23,900
HSPF BTU/hW	8.8	9.3	10.3
SEER BTU/hW	27.2	25.0	21.5
EER Clg/Htg	16.1/15.0	13.8/13.3	12.0/13.3
Clg. Operating Range °F(°C)	14~115 (-10~46)	14~115 (-10~46)	14~115 (-10~46)
Htg. Operating Range °F(°C)	-15~75 (-26~24)	-15~75 (-26~24)	-15~75 (-26~24)
Moisture Removal Pt./h(l/h)	2.75 (1.3)	3.8 (1.8)	4.44 (2.1)
Voltage/Frequency/Phase	208-230/60/1	208-230/60/1	208-230/60/1
MAX.CRT.BKR (A)	15	15	20
Air Circ. C.F.M. (m³/h): Hi	500 (850)	500 (850)	530 (900)
Medium	394 (670)	394 (670)	436 (740)
Low	324 (550)	324 (550)	336 (570)
Quiet	194 (330)	194 (330)	229 (390)
Noise Level dB(A): Hi	43/43	43/43	45/45
Medium	37/38	37/38	40/40
Low	32/32	32/32	33/34
Quiet	21/21	21/21	25/27
Outdoor Fan Speed RPM Clg/Htg	780/780	870/780	870/780
Outdoor Noise Level dB(A)	48/49	49/50	51/51
Current Rated (A): Cooling	2.7	4.0	5.5
Heating	3.7	5.5	6.1
Power Use Rated (kw): Cooling	.56	.87	1.21
Heating	.80	1.20	1.35
Fan Speeds Stage	4+Auto	4+Auto	4+Auto
Air Direction: Horizontal	Manual	Manual	Manual
Vertical	Auto	Auto	Auto
Air Filter	Washable	Washable	Washable
Apple Catechin Filter	Yes	Yes	Yes
Connection Method	Flare	Flare	Flare
Combined Min. Lgth Ft (m)	10 (3)	10 (3)	10 (3)
Combined Max. Lgth Ft (m)	66 (20) (pre-charge: 49')	66 (20) (pre-charge: 49')	66 (20) (pre-charge: 49')
Max. Vertical Diff. Ft (m)	49 (15)	49 (15)	49 (15)
Conn. Pipe Diameter Inch	Suc. 3/8 Dis. 1/4	Suc. 3/8 Dis. 1/4	Suc. 1/2 Dis. 1/4
Net Weight lbs. (kg)	21 (9.5)	88 (40)	21 (9.5)
Dimensions: Height Inch	11-1/8 13-1/4*	24-1/2	11-1/8 13-1/4*
mm	282/337*	620	282/337*
Width Inch	34-1/4	31-3/32	34-1/4
mm	870	790	870
Depth Inch	7-1/4	11-13/32	7-1/4
mm	185	290	185
Refrigerant	R410A	R410A	R410A

Indoor ASU9RLS2	Outdoor AOJ9RLS2H	Indoor ASU12RLS2	Outdoor AOJ12RLS2H	Indoor ASU15RLS2	Outdoor AOJ15RLS2H
-----------------	-------------------	------------------	--------------------	------------------	--------------------

Note: Figures are based on 230 Volts. \*Height when front panel is open.

# Wall Mounted HFI Single Zone 9, 12, 18 and 24,000 BTU

**9RLFW1, 12RLFW1, 18RLXFW, 24RLXFW**

(COMPATIBLE ONLY WITH HFI WALL MOUNT UNIT)



9RLFW1, 12RLFW1

18RLXFW, 24RLXFW

**Up to 23 SEER**

## Standard Features

- Wireless Remote Control
- Apple Catechin Filter
- Ion Deodorizing Filter
- Sleep Timer
- 24-Hour Timer
- Weekly Timer\*
- Dry Mode
- Auto Louver: Up/Down+
- Auto Louver: 4-way+
- Auto Mode
- Minimum Heat Mode
- Economy Mode
- Quiet Mode
- Power Diffuser+
- Auto Restart/Reset
- Auto Changeover
- Low Ambient Cooling
- Long Piping Length+
- Cold Prevention
- Remote Temp. Sensor+
- Pump Down Operation+
- 3rd Party Device Control\*\*

\* Available only with optional wired remote controller.

+ Feature of 9RLFW1 and 12RLFW1 only.

^ Feature of 18RLXFW and 24RLXFW only.

\*\* Operation monitoring and On/Off control only.

## Optional Accessories

- Wired Remote Controller: UTY-RVNUM\*  
*Backlit and includes room temperature*
- Wired Remote Controller: UTY-RNNUM\*
- Simple Remote Controller: UTY-RSNUM\*
- Dry Contact Wire Kit: UTY-XWZX++
- Dry Contact Wire Kit: UTY-XWZXZ5+
- Interface Kit: UTY-XCBXZ2+

\* Wall mounted ASU9, 12RLF1 require accessory interface kit #UTY-XCBXZ2 in order to connect these devices to them.

+ Compatible with ASU9, 12RLF1 only.

++ Compatible with ASU18, 24RLF only.

## #Adapter Fittings

Supplied in outdoor unit to be installed on the indoor unit.



Systems 9RLFW1, 12RLFW1

	9RLFW1	12RLFW1	18RLXFW	24RLXFW
	Heat Pump	Heat Pump	Heat Pump	Heat Pump
Nominal Cooling BTU/h	9,000	12,000	18,000	22,000
Min.~Max. Cooling BTU/h	1,700~10,900	3,100~13,300	7,000~23,000	9,900~27,300
Nominal Heating BTU/h	12,000	16,000	21,600	27,600
Min.~Max. Heating BTU/h	1,700~15,000	3,100~19,100	7,000~29,000	7,500~36,200
HSPF BTU/hW	11.0	11.0	10.0	10.0
SEER BTU/hW	23.0	22.0	19.2	18.0
EER Clg/Htg	13.8/13.5	12.5/12.5	13.3/12.0	12.5/11.6
Clg. Operating Range °F(°C)	14~115 (-10~46)	14~115 (-10~46)	14~115 (-10~46)	0~115 (-18~46)
Htg. Operating Range °F(°C)	5~75 (-15~24)	5~75 (-15~24)	5~75 (-15~24)	0~75 (-18~24)
Moisture Removal Pt./h(lb)	2.75 (1.3)	3.80 (1.8)	5.9 (2.8)	6.3 (3.0)
Voltage/Frequency/Phase	208-230/60/1	208-230/60/1	208-230/60/1	208-230/60/1
MAX.CRT.BKR (A)	20	20	20	30
Air Circ. C.F.M. (m <sup>3</sup> /h): Hi	441 (750)	441 (750)	541 (920)	659 (1,120) Clg 677 (1,150) Htg
Medium	376 (640)	376 (640)	435 (740)	500 (930)
Low	282 (480) Clg 306 (520) Htg	282 (480) Clg 306 (520) Htg	365 (620)	435 (740)
Quiet	182 (310) Clg 194 (330) Htg	182 (310) Clg 194 (330) Htg	306 (520) Clg 318 (540) Htg	365 (620)
Noise Level dB(A) (Clg/Htg): Hi	43/43	43/43	43/44	49/49
Medium	40/38	40/38	37/37	42/42
Low	32/33	32/33	33/33	37/37
Quiet	21/22	21/22	28/28	33/33
Outdoor Fan Speed RPM Clg/Htg	780/720	780/680	620/620	800/850
Outdoor Noise Level dB(A) Clg/Htg	48/48	49/49	47/50	54/55
Current Rated/Max (A): Cooling	3.2/6.0	4.4/6.5	6.2/13.5	7.9/15.0
Heating	4.2/7.5	5.9/9.0	8.0/14.5	10.5/15.5
Power Use Rated/Max (kw): Cooling	0.65/1.27	0.96/1.40	1.35/3.01	1.76/3.42
Heating	0.89/1.60	1.28/1.99	1.80/3.23	2.38/3.53
Fan Speeds Stage	4+Auto	4+Auto	4+Auto	4+Auto
Air Direction: Horizontal	Manual	Manual	Automatic	Automatic
Vertical	Automatic	Automatic	Automatic	Automatic
Air Filter	Washable	Washable	Washable	Washable
Apple Catechin Filter	Yes	Yes	Yes	Yes
Connection Method	Flare	Flare	Flare	Flare
Combined Min. Lgth Ft (m)	10 (3)	10 (3)	16 (5)	16 (5)
Combined Max. Lgth Ft (m)	66 (20.1) (pre-charge: 49')	66 (20.1) (pre-charge: 49')	164 (50) (pre-charge: 66')	164 (50) (pre-charge: 66')
Max. Vertical Diff. Ft (m)	49 (15)	49 (15)	98 (30)	98 (30)
Conn. Pipe Diameter Inch	Suc. 3/8/Dis. 1/4	Suc. 3/8/Dis. 1/4	Suc. 5/8* Dis. 3/8*	Suc. 5/8* Dis. 3/8*
Net Weight lbs. (kg)	18 (8) 60 (27)	18 (8) 80 (36)	31 (14) 135 (61)	31 (14) 135 (61)
Dimensions: Height Inch	11-1/16 21-1/4	11-1/16 21-1/4	12-5/8 32-3/4	12-5/8 32-3/4
mm	280 540	280 540	320 830	320 830
Width Inch	31-1/16 26	31-1/16 31	39-1/4 35-3/8	39-1/4 35-3/8
mm	790 660	790 790	998 900	998 900
Depth Inch	8 11-7/16	8 11-7/16	9 13	9 13
mm	203 290	203 290	228 330	228 330
Refrigerant	R410A	R410A	R410A	R410A
Indoor ASU9RLF1	Indoor ASU12RLF1	Indoor ASU18RLF	Indoor ASU24RLF	Indoor ASU24RLF
Outdoor AOU9RLFW1	Outdoor AOU12RLFW1	Outdoor AOU18RLXFW	Outdoor AOU24RLXFW	Outdoor AOU24RLXFW

Note: Figures are based on 230 Volts.

# Wall Mounted 30,000 BTU Systems

## SYSTEM 30RLX



### Function

This wall mounted heat pump provides both heating and cooling for year-round comfort. Ultra compact yet efficient, System 30RLX provides maximum comfort in 30% less space while saving you money. Additionally, System 30RLX provides low ambient operation rated down to 0°F right out of the box without modification.

### Standard Features

- Wireless Remote Control
- Apple Catechin Filter
- Ion Deodorizing Filter
- Sleep Timer
- 24-Hour Timer
- Weekly Timer\*
- Dry Mode
- Auto Louver: 4-way
- Auto Mode
- Minimum Heat Mode
- Economy Mode
- Quiet Mode (Indoor)
- Power Diffuser
- Auto Restart/Reset
- Auto Changeover
- 0°F Ambient Cooling
- Long Piping Length
- Cold Prevention
- Pump Down Operation
- 3<sup>rd</sup> Party Device Control\*\*

\* Available only with optional wired remote controller.  
\*\* Operation monitoring and On/Off control only.

### Optional Wired Remote

- Weekly Timer
- Full Function Wired Remote
- Child Lock Capable



### Easy Maintenance

Front panel is easily removed for cleaning.



### Applications

Fujitsu ductless heat pumps can be used to solve various application-specific problems. Businesses and institutions such as schools, churches, nursing homes and hospitals, commercial office buildings, strip malls, motels and restaurants, apartments and condos, computer and telephone switching rooms, and even residences commonly use these systems. With more efficient zone control, "ductless mini-splits" are perfect for renovations, restorations, conversions, and add-ons.

30RLX Heat Pump	
Nominal Cooling BTU/h	30,000
Min.~Max. Cooling BTU/h	9,900~32,400
Nominal Heating BTU/h	32,000
Min.~Max. Heating BTU/h	8,000~37,500
HSPF BTU/hW	9.5
SEER BTU/hW	17.5
EER Clg/Htg	10.0
Clg. Operating Range °F(°C)	0~115 (-18~46)
Htg. Operating Range °F(°C)	0~75 (-18~24)
Moisture Removal Pt./h(l/h)	9.5 (4.5)
Voltage/Frequency/Phase	208-230/60/1
MAX.CRT.BKR (A)	30
Air Circ. C.F.M. (m <sup>3</sup> /h): Hi	659 (1,120) Clg 677 (1,150) Htg
Medium	530 (900)
Low	435 (740)
Quiet	365 (620)
Noise Level dB(A): Hi	49/49 (Clg/Htg)
Medium	42/42 (Clg/Htg)
Low	37/37 (Clg/Htg)
Quiet	33/33 (Clg/Htg)
Outdoor Fan Speed RPM Clg/Htg	850/850
Outdoor Noise Level dB(A)	54/55 (Clg/Htg)
Current Rated/Max (A): Cooling	13.2/17.0
Heating	13.1/18.5
Power Use Rated/Max (kw): Cooling	3.0/3.87
Heating	2.99/4.22
Fan Speeds Stage	4 + Auto
Air Direction: Horizontal	Automatic
Vertical	Automatic
Air Filter	Washable
ENERGY STAR® Qualified	No
Connection Method	Flare
Combined Min. Lgth Ft (m)	16 (5)
Combined Max. Lgth Ft (m)	164 (50) (pre-charge: 66')
Max. Vertical Diff. Ft (m)	98 (30)
Conn. Pipe Diameter Inch	Suc. 5/8 Dis. 3/8
Net Weight lbs. (kg)	31 (14) 135 (61)
Dimensions: Height Inch	12-5/8 32-3/4
mm	320 830
Width Inch	39-1/4 35-3/8
mm	998 900
Depth Inch	9 13
mm	228 330
Refrigerant	R410A

Indoor  
ASU30RLX  
Outdoor  
AOU30RLX



Note: Figures are based on 230 Volts.

# Wall Mounted 18, 24, 30 and 36,000 BTU Cooling Systems

SYSTEMS 18CL, 24CL1, 30CLX1, 36CLX1

Up to 19.0 SEER



## Function

Stylish, slim and elegant, these cooling-only wall mounted units are designed for single rooms. Indoor units have a clean, aesthetic design and are small but mighty and shorter in length than competing units, helping them blend into any room.

## Standard Features

- Wireless Remote Control
- Apple Catechin Filter
- Ion Deodorizing Filter
- Sleep Timer
- 24-Hour Timer
- Weekly Timer\*
- Dry Mode
- Auto Louver: Up/Down+
- Auto Louver: 4 Way^
- Auto Mode
- Quiet Mode
- Power Diffuser^
- Auto Restart/Reset
- Low Ambient Cooling
- Long Piping Length#
- Pump Down Operation#
- 3<sup>rd</sup> Party Device Control\*



\* Available only with optional wired remote controller.  
 + Feature of 18CL only.  
 ^ Feature of 24CL1, 30CLX1, 36CLX1 only. Operation monitoring and On/Off control only.  
 # Feature of 30CLX1 and 36CLX1 only.

## Optional Wired Remote

- Weekly Timer
- Full Function Wired Remote
- Child Lock Capable



	18CL	24CL1	30CLX1	36CLX1
	Cooling Only Cooling Only Cooling Only Cooling Only			
Nominal Cooling BTU/h	18,000	24,000	30,800	33,000
Min.~Max. Cooling BTU/h	5,500~19,000	3,100~25,000	9,900~32,400	9,900~34,100
SEER BTU/hW	19.0	17.5	16.5	15.5
EER Clg	10.4	10.0	9.5	8.5
Clg. Operating Range °F(°C)	14~115 (-10~46)	14~115 (-10~46)	14~115 (-10~46)	14~115 (-10~46)
Moisture Removal Pt./h(lb)	5.9 (2.8)	6.3 (3.0)	9.7 (4.6)	10.1 (4.8)
Voltage/Frequency/Phase	208-230/60/1	208-230/60/1	208-230/60/1	208-230/60/1
MAX.CRT.BKR (A)	20	20	30	30
Air Circ. C.F.M. (m <sup>3</sup> /h): Hi	412 (700)	659 (1,120)	660 (1,100)	695 (1,180)
Medium	342 (581)	530 (900)	530 (900)	530 (900)
Low	271 (460)	436 (740)	435 (740)	435 (740)
Quiet	218 (370)	365 (620)	365 (620)	365 (620)
Noise Level dB(A): Hi	44	48	49	50
Medium	38	42	42	42
Low	32	37	37	37
Quiet	25	33	33	33
Outdoor Fan Speed RPM Clg	860	1,100	2,119	2,119
Outdoor Noise Level dB(A)	50	56	54	54
Current Rated/Max (A): Cooling	7.7/9.0	10.5/11.5	14.2/17.0	17.0/18.0
Power Use Rated/Max (kw): Cooling	1.73/2.0	2.4/2.5	3.24/3.87	3.88/4.10
Fan Speeds Stage	4 + Auto	4 + Auto	4 + Auto	4 + Auto
Air Direction: Horizontal	Manual	Automatic	Automatic	Automatic
Vertical	Automatic	Automatic	Automatic	Automatic
Air Filter	Washable	Washable	Washable	Washable
Connection Method	Flare	Flare	Flare	Flare
Combined Min. Lgth Ft (m)	10 (3)	10 (3)	16 (5)	16 (5)
Combined Max. Lgth Ft (m)	66 (20)	98 (30)	164 (50)	164 (50)
	(pre-charge: 49')	(pre-charge: 49')	(pre-charge: 66')	(pre-charge: 66')
Max. Vertical Diff. Ft (m)	49 (15)	66 (20)	98 (30)	98 (30)
Conn. Pipe Diameter Inch	Suc. 1/2 Dis. 1/4	Suc. 5/8 Dis. 1/4	Suc. 5/8 Dis. 3/8	Suc. 5/8 Dis. 3/8
Net Weight lbs. (kg)	20 (9)	88 (40)	31 (14)	88 (40)
Dimensions: Height Inch	10-13/16	22-3/4	12-5/8	24-7/16
mm	275	578	320	620
Width Inch	31-1/8	31-1/8	39-1/4	31-1/8
mm	790	790	998	790
Depth Inch	8-7/16	11-13/16	9	11-3/4
mm	215	300	228	298
Refrigerant	R410A	R410A	R410A	R410A
Indoor ASU18CL	Indoor ASU24CL1	Indoor ASU30CLX1	Indoor ASU36CLX1	
Outdoor AOU18CL	Outdoor AOU24CL1	Outdoor AOU30CLX1	Outdoor AOU36CLX1	



System 18CL  
 Systems 24CL1, 30/36CLX1

Note: Figures are based on 230 Volts.

# Ceiling and Universal Floor/Ceiling Mounted Systems

## SYSTEMS 18RULX, 24RULX, 36RSLX



**Up to 16 SEER**

### Function

The 18RULX and the 24RULX are universal mount. They can mount low on the wall or transverse mount them on the ceiling. The 36RSLX can only be mounted on the ceiling, can take in fresh air and can throw air farther.

### Standard Features

- Wireless Remote Control
- Sleep Timer
- 24 Hour Timer
- Weekly Timer\*
- Dry Mode
- Auto Louver: 4 Way
- Auto Mode
- Auto Restart/Reset
- Auto Changeover
- 0°F Ambient Cooling
- Long Piping Length
- Cold Prevention
- Energy Saver\*
- Remote Temp. Sensor\*
- Daisy Chain
- Pump Down Operation
- High Ceiling Mode
- Fresh Air Intake^

\*Available only with optional wired remote controller.

^Fresh air knockout available. Fresh air fan and ductwork field supplied. See Design and Technical Manual for details

### Optional Accessories

- Wired Remote Control UTY-RNBYU\*
  - Weekly Timer
  - Full Function Wired Remote
  - Child Lock Capable

\*Requires dip switch change on indoor unit.
- Condensate Pump UTR-DP24T
  - OEM design plug and play
  - Rated for 11.8" of vertical lift.

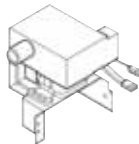

### Applications

The universal mount 18RULX and 24RULX are ideal for a house of worship to mount beneath stained glass windows. Lower in height than the pews, they do not disturb the aesthetics of the space. With long piping lengths of 165' the outdoor units can also be placed remotely out of sight. Another popular application for this model is in hallways where wall space is limited. The 36RSLX is popular where fresh air intake and high capacity is required like a restaurant or bar. They are also often suspended from threaded rod and used in multiple to condition large warehouse spaces.

	18RULX Heat Pump	24RULX Heat Pump	36RSLX Heat Pump
Nominal Cooling BTU/h	17,800	22,200	34,100
Min.~Max. Cooling BTU/h	5,000~21,600	5,000~27,300	8,500~36,000
Nominal Heating BTU/h	21,500	24,000	36,500
Low Heating 17°F BTU/h	13,000	15,000	23,400
Min.~Max. Heating BTU/h	5,000~25,600	5,000~29,000	9,200~42,700
HSPF BTU/hW	8.5	8.5	8.5
SEER BTU/hW	16.0	15.0	14.0
EER Clg/Htg	10.9/9.6	9.9/10.2	8.1/10.4
Clg. Operating Range °F(°C)	0~115 (-18~46)	0~115 (-18~46)	0~115 (-18~46)
Htg. Operating Range °F(°C)	14~75 (-10~24)	14~75 (-10~24)	14~75 (-10~24)
Moisture Removal Pt./h(l/h)	5.3 (2.5)	7.4 (3.5)	7.4 (3.5)
Voltage/Frequency/Phase	208-230/60/1	208-230/60/1	208-230/60/1
MAX.CRT.BKR (A)	20	20	30
Air Circ. C.F.M. (m <sup>3</sup> /h): Hi	459 (780)	518 (880)	1089 (1850)
Medium	383 (650)	436 (740)	977 (1660)
Low	324 (550)	371 (630)	842 (1430)
Noise Level dB(A): Hi	43/43 (Clg/Htg)	47/47 (Clg/Htg)	48/48 (Clg/Htg)
Medium	39/39 (Clg/Htg)	43/43 (Clg/Htg)	45/43 (Clg/Htg)
Low	35/35 (Clg/Htg)	38/38 (Clg/Htg)	41/39 (Clg/Htg)
Outdoor Fan Speed RPM	780/780	850/900	850/900
Outdoor Noise Level dB(A)	51/53	53/55	54/55
Current Rated/Max (A): Cooling	7.1/12.5	9.8/12.5	18.3/18.8
Heating	9.8/12.5	10.2/12.5	15.3/18.8
Power Use Rated/Max (kw): Cooling	1.63/2.88	2.25/2.88	4.22/4.35
Heating	2.25/2.88	2.35/2.88	3.50/4.35
Fan Speeds Stage	3 + Auto	3 + Auto	3 + Auto
Air Direction: Horizontal	Automatic	Automatic	Automatic
Vertical	Automatic	Automatic	Automatic
Air Filter	Washable	Washable	Washable
Front Grille	Permanent	Permanent	Permanent
Connection Method	Flare	Flare	Flare
Combined Min. Lgth Ft (m)	16 (5)	16 (5)	16 (5)
Combined Max. Lgth Ft (m)	165 (50) (pre-charge: 49')	165 (50) (pre-charge: 49')	165 (50) (pre-charge: 49')
Max. Vertical Diff. Ft (m)	66 (20)	66 (20)	98 (30)
Conn. Pipe Diameter Inch	Suc.1/2 Dis. 1/4	Suc.5/8 Dis. 3/8	Suc.5/8 Dis. 3/8
Net Weight lbs. (kg)	62 (28)	141 (64)	106 (48)
Dimensions: Height Inch	7-7/8	32-3/4	7-7/8
mm	199	830	199
Width Inch	39-1/8	35-1/2	39-1/8
mm	990	900	990
Depth Inch	25-7/8	13	25-7/8
mm	655	330	655
Refrigerant	R410A	R410A	R410A
	Indoor ABU18RULX	Outdoor AOU18RLX	Indoor ABU24RULX
			Outdoor AOU24RLX
			Indoor ABU36RSLX
			Outdoor AOU36RLX

Note: Figures are based on 230 Volts.



# Floor Mount Single Zone 9, 12 and 15,000 BTU Systems

SYSTEMS 9RLFF, 12RLFF, 15RLFF



Up to 26 SEER

Floor mount systems are ideal for residential radiator replacements or any room with limited upper wall space.



At less than 24" high and 30" wide, floor mount models fit easily under a standard window and can replace a radiator twice its size while producing more capacity.

## Standard Features for RLFF and RLFFH Models

- Wireless Remote Control
- Apple Catechin Filter
- Ion Deodorizing Filter
- Sleep Timer
- 24-Hour Timer
- Auto Louver: Up/Down
- Auto Mode
- Minimum Heat Mode
- Economy Mode
- Auto Restart/Reset
- Auto Changeover
- Powerful Mode

## Flexible and Easy Installation

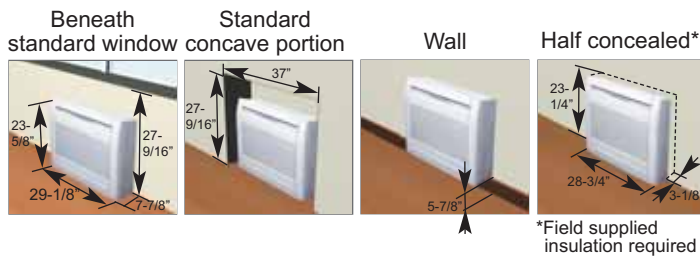

## Accessories for RLFF and RLFFH Models

- Wired Remote Controller: UTY-RVNUM  
Backlit and includes room temperature
- Wired Remote Controller: UTY-RNNUM
- Simple Remote Controller: UTY-RSNUM
- Dry Contact Wire Kit: UTY-XWZXZ5

Low Temperature Heating Down to -5°F

	9RLFF Heat Pump	12RLFF Heat Pump	15RLFF Heat Pump
Nominal Cooling BTU/h	9,000	12,000	14,200
Min.~Max. Cooling BTU/h	3,100~13,000	3,100~14,300	3,100~17,700
Nominal Heating BTU/h	12,000	16,000	18,000
Min.~Max. Heating BTU/h	3,100~18,800	3,100~22,100	3,100~23,900
HSPF BTU/hW	12.6	11.6	11.2
SEER BTU/hW	26.0	22.7	20.3
EER Clg/Htg	16.0/13.6	13.1/11.1	12.5/11.3
Clg. Operating Range °F(°C)	14~115 (-10~46)	14~115 (-10~46)	14~115 (-10~46)
Htg. Operating Range °F(°C)	-5~75 (-21~24)	-5~75 (-21~24)	-5~75 (-21~24)
Moisture Removal Pt./h(h)	2.75 (1.3)	3.8 (1.8)	4.44 (2.1)
Voltage/Frequency/Phase	208-230/60/1	208-230/60/1	208-230/60/1
MAX.CRT.BKR (A)	15	15	20
Air Circ. C.F.M. (m/h): Hi	335 (570)	335 (570)	383 (650)
Medium	271 (460)	271 (460)	306 (520)
Low	212 (360)	212 (360)	235 (400)
Quiet	159 (270)	159 (270)	159 (270)
Noise Level dB(A)Clg/Htg: Hi	40/40	40/40	44/43
Medium	35/35	35/35	38/37
Low	29/29	29/29	31/29
Quiet	23/23	23/23	23/23
Outdoor Fan Speed RPM Clg/Htg	870/870	1,050/870	1,050/1,000
Outdoor Noise Level dB(A) Clg/Htg	50/50	52/52	54/54
Current Rated (A): Cooling	2.9	4.2	5.1
Heating	4.1	6.7	7.0
Power Use Rated (kw): Cooling	.56	.97	1.13
Heating	.88	1.44	1.58
Fan Speeds Stage	4+Auto	4+Auto	4+Auto
Air Direction: Horizontal	Manual	Manual	Manual
Vertical	Auto	Auto	Auto
Air Filter	Washable	Washable	Washable
Apple Catechin Filter	Yes	Yes	Yes
Ion Deodorizing Filter	Yes	Yes	Yes
Connection Method	Flare	Flare	Flare
Combined Min. Lgth Ft (m)	10 (3)	10 (3)	10 (3)
Combined Max. Lgth Ft (m)	66 (20)	66 (20)	66 (20)
Max. Vertical Diff. Ft (m)	49 (15)	49 (15)	49 (15)
Conn. Pipe Diameter Inch	Suc. 3/8 Dis. 1/4	Suc. 3/8 Dis. 1/4	Suc. 1/2 Dis. 1/4
Net Weight lbs. (kg)	31 (14)	84 (38)	31 (14)
Dimensions: Height Inch	23-5/8	24-7/16	23-5/8
mm	600	620	600
Width Inch	29-1/8	31-1/8	29-1/8
mm	740	790	740
Depth Inch	7-7/8	11-7/16	7-7/8
mm	200	290	200
Refrigerant	R410A	R410A	R410A
Indoor	AGU9RLF	AGU12RLF	AGU15RLF
Outdoor	AOU9RLFF	AOU12RLFF	AOU15RLFF

Note: Figures are based on 230 Volts.





# Floor Mount Single Zone 9, 12 and 15,000 BTU Systems

## SYSTEMS 9RLFFH, 12RLFFH, 15RLFFH



Up to 26 SEER

### Base Pan Heater RLFFH Models Only

- Equipped with a base heater that prevents condensate from freezing
- Cultivated base design discharges melted water through many holes.
- Without a heater, freezing condensate can cause noise, damage to fan blade, condenser, and system performance.

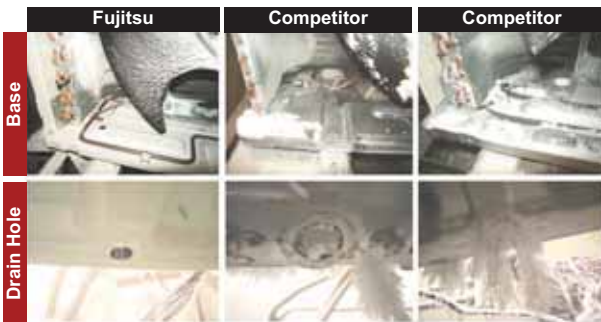

Drain hole is not filled, no freezing of base | Freezing where there is no heater | Drain hole is closed, large freezing of base

Condition: Indoor temp. of 68°FDB / outdoor temp. of 5°FDB, Heating mode, High airflow volume. Operation for 24 hours.

### 2-Fan and Wide Airflow

Having both upper and lower airflow quickly warms or cools the entire room. Floor mount can be set in "Upward Airflow Only" when occupants wish not to have feet warmed or cooled.

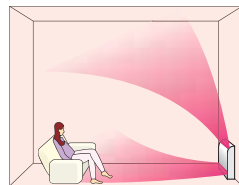

### Applications



Extra Low Temperature Heating Down to -15°F			
	9RLFFH Heat Pump	12RLFFH Heat Pump	15RLFFH Heat Pump
Nominal Cooling BTU/h	9,000	12,000	14,200
Min.-Max. Cooling BTU/h	3,100~13,000	3,100~14,300	3,100~17,700
Nominal Heating BTU/h	12,000	16,000	18,000
Min.-Max. Heating BTU/h	3,100~18,800	3,100~19,500	3,100~20,800
HSPF BTU/hW	12.4	11.3	11.0
SEER BTU/hW	26.0	22.7	20.3
EER Clg/Htg	16.0/13.6	13.1/11.1	12.5/11.3
Clg. Operating Range °F(°C)	14~115 (-10~46)	14~115 (-10~46)	14~115 (-10~46)
Htg. Operating Range °F(°C)	-15~75 (-26~24)	-15~75 (-26~24)	-15~75 (-26~24)
Moisture Removal Pt./h(lh)	2.75 (1.3)	3.8 (1.8)	4.44 (2.1)
Voltage/Frequency/Phase	208-230/60/1	208-230/60/1	208-230/60/1
MAX.CRT.BKR (A)	15	15	20
Air Circ. C.F.M. (m <sup>3</sup> /h): Hi	335 (570)	335 (570)	383 (650)
Medium	271 (460)	271 (460)	306 (520)
Low	212 (360)	212 (360)	235 (400)
Quiet	159 (270)	159 (270)	159 (270)
Noise Level dB(A)Clg/Htg: Hi	40/40	40/40	44/43
Medium	35/35	35/35	38/37
Low	29/29	29/29	31/29
Quiet	23/23	23/23	23/23
Outdoor Fan Speed RPM Clg/Htg	870/870	1,050/870	1,050/1,000
Outdoor Noise Level dB(A) Clg/Htg	50/50	52/52	54/54
Current Rated (A): Cooling	2.9	4.2	5.1
Heating	4.1	6.7	7.0
Power Use Rated (kw): Cooling	.56	.97	1.13
Heating	.88	1.44	1.58
Fan Speeds Stage	4+Auto	4+Auto	4+Auto
Air Direction: Horizontal	Manual	Manual	Manual
Vertical	Auto	Auto	Auto
Air Filter	Washable	Washable	Washable
Apple Catechin Filter	Yes	Yes	Yes
Ion Deodorizing Filter	Yes	Yes	Yes
Connection Method	Flare	Flare	Flare
Combined Min. Lgth Ft (m)	10 (3)	10 (3)	10 (3)
Combined Max. Lgth Ft (m)	66 (20)	66 (20)	66 (20)
	(pre-charge: 49')	(pre-charge: 49')	(pre-charge: 49')
Max. Vertical Diff. Ft (m)	49 (15)	49 (15)	49 (15)
Conn. Pipe Diameter Inch	Suc. 3/8 Dis. 1/4	Suc. 3/8 Dis. 1/4	Suc. 1/2 Dis. 1/4
Net Weight lbs. (kg)	31 (14)	86 (39)	31 (14)
	86 (39)	31 (14)	88 (40)
Dimensions: Height Inch	23-5/8	24-7/16	23-5/8
	24-7/16	23-5/8	24-7/16
mm	600	620	600
	620	600	620
Width Inch	29-1/8	31-1/8	29-1/8
	31-1/8	29-1/8	31-1/8
mm	740	790	740
	790	740	790
Depth Inch	7-7/8	11-7/16	7-7/8
	11-7/16	7-7/8	11-7/16
mm	200	290	200
	290	200	290
Refrigerant	R410A	R410A	R410A
Indoor AGU9RLF			
Outdoor AO9RLFFH			
Indoor AGU12RLF			
Outdoor AO12RLFFH			
Indoor AGU15RLF			
Outdoor AO15RLFFH			

Note: Figures are based on 230 Volts.



# Slim Duct Single Zone 9, 12 and 18,000 BTU Systems

SYSTEMS 9RLFCD, 12RLFCD, 18RLFCD



## Function



Slim ducts provide comfort cooling or heating for small room applications. Features include high efficiency up to 21.5 SEER,

heating at low temperatures down to -5°F, compact design, quiet operation, a standard wired remote control, and the ability to bring in fresh air.

## High Performance Heating

Heating capacity at low outdoor temperatures is achieved by adopting a large heat exchanger and a high capacity compressor. Systems operate down to -5°F.

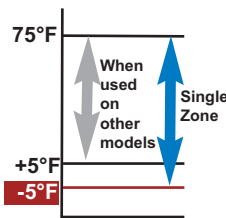

## Standard Features

- Wired Remote Control
- Auto Changeover
- Weekly Timer
- Low Ambient Cooling
- Dry Mode
- Cold Prevention
- Auto Mode
- Daisy Chain
- Economy Mode
- Built-In Condensate Pump
- Minimum Heat\* Auto
- 3rd Party Device Control^
- Auto Restart/Reset

\*Available only with optional wireless remote controller.  
^Operation monitoring and On/Off control only.

## Applications

Long maximum combined piping length of 66' and 49' in height allow for versatile installations. Flexible installation, either horizontal or vertical, and low height enables compact soffit or cabinet installation. These features make slim duct systems ideal for commercial applications such as offices, restaurants, convenience stores, motels, dorms, in retrofit and new construction.



Multi-Tenant Dwellings



Hotels / Motels



Dorms

## Optional Accessories

- Backlit Wired Remote Control UTY-RVNUM *Displays room temp.*
- Wireless Remote and Receiver Unit UTY-LRHUM



UTY-RVNUM

## System Components

- |                      |                       |                       |
|----------------------|-----------------------|-----------------------|
| <b>System 9RLFCD</b> | <b>System 12RLFCD</b> | <b>System 18RLFCD</b> |
| • ARU9RLF (Indoor)   | • ARU12RLF (Indoor)   | • ARU18RLF (Indoor)   |
| • AOU9RLF (Outdoor)  | • AOU12RLF (Outdoor)  | • AOU18RLF (Outdoor)  |

## Field Supplied Filters Used With Slim Duct Units

Although Slim Duct units come with factory filters, when return ductwork is used field supplied filters are more practical to use. They can be installed at the unit or for more convenient servicing, in filter grilles. See the guidelines to the right to determine filter sizes.

The chart includes CFM, external static pressure capability and a typical filter size for each model. Filters are sized to keep velocities and static pressure loss low. This will ensure sufficient static pressure is available for ductwork, fittings and supply and return grilles.

Alternative filter sizes with equivalent face areas can be used. After deducting filter loss, available static pressure values are shown.



A fiberglass filter is shown in blue to the left. A MERV pleated filter is shown in white.

	ARU 9RLF	ARU 12RLF	ARU 18RLF
CFM	353	353	547
Typical Filter Size	12 x 20	12 x 20	14 x 25
Velocity, FPM	212	212	225
Unit External SP, in. W.C.	0.36	0.36	0.36
<b>1" Fiberglass Filter</b>			
SP Loss, in. W.C.	0.04	0.04	0.04
Available Static Pressure	0.32	0.32	0.32
<b>1" MERV 8 Pleated Filter</b>			
SP Loss, in. W.C.	0.12	0.12	0.14
Available Static Pressure	0.24	0.24	0.22
<b>2" MERV 8 Pleated Filter</b>			
SP Loss, in. W.C.	0.07	0.07	0.08
Available Static Pressure	0.29	0.29	0.28

## Slim Duct

Built-in drain pump allows for installation of slim duct unit in smaller spaces than traditional units.

### Traditional



### Compact Duct



## Return Air-intake Choices

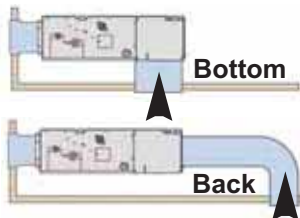

## Flexible Installation

Horizontal or vertical.

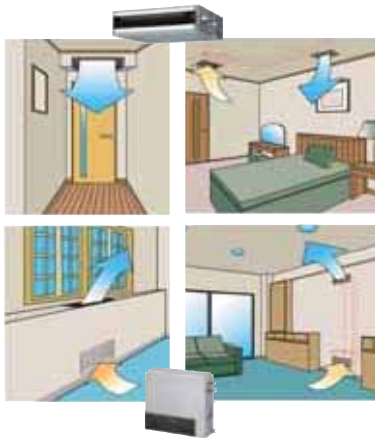

\*Internal drain pump will not operate when the unit is mounted in a vertical configuration.



	9RLFCF Heat Pump	12RLFCF Heat Pump	18RLFCF Heat Pump
Nominal Cooling BTU/h	9,000	12,000	18,000
Min~Max Cooling BTU/h	3,100~12,000	3,100~13,600	3,100~20,100
Nominal Heating BTU/h	12,000	16,000	21,600
Min~Max Heating BTU/h	3,100~18,000	3,100~19,400	3,100~25,600
HSPF	12.2	11.5	11.3
SEER	21.5	20.0	19.7
EER Clg/Htg	14.5/14.1	12.8/12.3	12.0/12.9
Cooling Operating Range °F(°C)	14~115 (-10~46)	14~115 (-10~46)	14~115 (-10~46)
Heating Operating Range °F(°C)	-5~75 (-21~24)	-5~75 (-21~24)	-5~75 (-21~24)
Moisture Removal Pt./h(l/h)	1.5 (.07)	2.7 (1.3)	4.2 (2.0)
Voltage/Frequency/Phase	208-230/60/1	208-230/60/1	208-230/60/1
MAX.CRT.BKR (A)	15	15	20
Static Pressure In. W. C.	0 ~ 0.36	0 ~ 0.36	0 ~ 0.36
Air Circ. C.F.M. (m <sup>3</sup> /h) Clg/Htg: Hi	353 (600)	383 (650)	554 (940)
Medium	324 (550)	353 (600)	518 (880)
Low	294 (500)	324 (550)	483 (820)
Quiet	265 (450)	283 (480)	442 (750)
Noise Level dB(A) (Clg/Htg): Hi	28/28	29/29	32/32
Medium	27/26	28/28	30/30
Low	26/25	27/27	29/29
Quiet	25/24	26/24	27/27
Outdoor Fan Speed RPM Clg/Htg	590/720	870/780	870/1,000
Outdoor Noise Level Clg/Htg	48/49	49/50	54/55
Running Current Rated (A)Clg/Htg	3.0/3.9	4.4/6.0	6.6/7.3
Power Use Rated/Max (kW): Cooling	0.62/1.40	0.94/1.45	1.50/2.15
Heating	0.85/1.80	1.30/2.00	1.67/2.60
Fan Speeds Stage	4 + Auto	4 + Auto	4 + Auto
Air Filter	Washable	Washable	Washable
Connection Method	Flare	Flare	Flare
Combined Min. Length Ft (m)	10 (3)	10 (3)	10 (3)
Combined Max. Length Ft (m)	66 (20) (pre-charge: 49')	66 (20) (pre-charge: 49')	66 (20) (pre-charge: 49')
Max. Vertical Diff. Ft (m)	49 (15)	49 (15)	49 (15)
Conn. Pipe Diameter Inch	suc 3/8 dis 1/4	suc 3/8 dis 1/4	suc 1/2 dis 1/4
Indoor Unit Net Weight lbs. (kg)	41 (19)	41 (19)	50 (23)
Outdoor Unit Net Weight lbs. (kg)	84 (38)	84 (38)	86 (39)
Indoor Unit Dimensions: Height Inch (mm)	7-25/32 (198)	7-25/32 (198)	7-25/32 (198)
Width Inch (mm)	27-9/16 (700)	27-9/16 (700)	35-7/16 (900)
Depth Inch (mm)	24-13/32 (620)	24-13/32 (620)	24-13/32 (620)
Supply Duct Flange Dimensions: Height Inch (mm)	5-15/16 (151)	5-15/16 (151)	5-15/16 (151)
Width Inch (mm)	25-19/32 (650)	25-19/32 (650)	33-15/32 (850)
Depth Inch (mm)	3/4 (19)	3/4 (19)	3/4 (19)
Return Duct Dimensions: Height Inch (mm)	6 (152)	6 (152)	6 (152)
Width Inch (mm)	22 (559)	22 (559)	30 (762)
Depth Inch (mm)	3/4 (19) (Flat)	3/4 (19) (Flat)	3/4 (19) (Flat)
Outdoor Unit Dimensions: Height Inch (mm)	24-1/2 (620)	24-1/2 (620)	24-1/2 (620)
Width Inch (mm)	31-3/32 (790)	31-3/32 (790)	31-3/32 (790)
Depth Inch (mm)	11-11/32 (290)	11-11/32 (290)	11-11/32 (290)
Refrigerant	R410A	R410A	R410A



Systems 9RLFCF, 12RLFCF

Note: Figures are based on 230 Volts.

# Compact Cassette Single Zone 9, 12 and 18,000 BTU

SYSTEMS 9RLFCC, 12RLFCC, 18RLFCC



Up to 24.0 SEER

## Function



Compact cassettes provide comfort cooling or heating for small room applications. Features include high efficiency up to 24.0 SEER, heating at low temperatures down to -5°F, compact design, quiet operation, a standard wired remote control, and the ability to bring in fresh air through the optional Fresh Air Kit.

to 24.0 SEER, heating at low temperatures down to -5°F, compact design, quiet operation, a standard wired remote control, and the ability to bring in fresh air through the optional Fresh Air Kit.

## High Performance Heating

Heating capacity at low outdoor temperatures is achieved by adopting a large heat exchanger and a high capacity compressor. Systems operate down to -5°F.

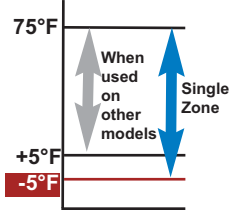

## Standard Features

- Wired Remote Control
- Weekly Timer
- Dry Mode
- Auto Louver: Up/ Down
- Auto Mode
- Minimum Heat\*
- Economy Mode
- Auto Restart/Reset
- Auto Changeover
- Low Ambient Cooling
- Cold Prevention
- Daisy Chain
- High Ceiling Mode
- Condensate Pump
- Fresh Air Intake\*\*
- 3rd Party Device Control^



**Fresh Air Kit\*\***  
UTZ-VXAA  
Mixes room air then passes through the heat exchanger.

## Optional Accessories

- Backlit Wired Remote Control UTY-RVNUM *Displays room temp.*
- Wireless remote UTY-LNHUM



UTY-RVNUM

## Applications

Long maximum combined piping length of 66' and 49' in height allow for versatile installations. 4-way airflow, concealed flush mount design and the ability to operate in limited space above the drop ceiling, makes these systems ideal for commercial applications such as offices, restaurants, convenience stores, motels, dorms, in retrofit and new construction.



Multi-Tenant Dwellings



Hotels / Motels



Dorms



## System Components

System 9RLFCC	System 12RLFCC	System 18RLFCC
• AUU9RLF (Indoor)	• AUU12RLF (Indoor)	• AUU18RLF (Indoor)
• AOU9RLF (Outdoor)	• AOU12RLF (Outdoor)	• AOU18RLF (Outdoor)

\* Available only with optional wireless remote control.

\*\*Requires Fujitsu's Optional Fresh Air Kit part #UTZ-VXAA. Allows for a 4-inch flex duct connection. Requires a field supplied duct booster fan capable of 60 CFM at .2"W.C. or 90 CFM at .4"W.C. For fan static pressure requirements, see installation manual. Add hood, filter and duct losses for fan total static pressure requirements. Will add 4" to the height of the indoor unit.

^ Operation monitoring and On/Off control only.

## Easy Installation

Fits into a standard ceiling tile\*.

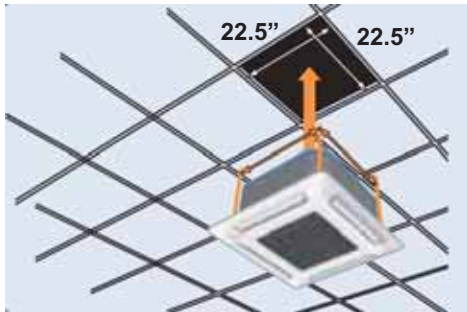

\*Dimensions of outer grille are 27-9/16" x 27-9/16" and may overlap adjacent tiles.

## 2-Stage Turbo Fan

Air distribution is evenly spread across the heat exchanger by the 2 stage turbo fan which produces two separate airflow streams.

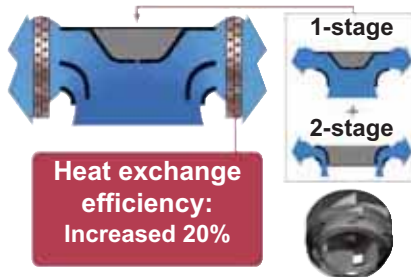

## Quiet Operation

Optimization of wing form (laminar wing design) and number of wings (7 blades) enables as low as 27 dB.

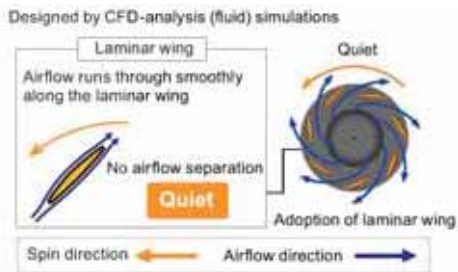

	9RLFCC Heat Pump	12RLFCC Heat Pump	18RLFCC Heat Pump
Nominal Cooling BTU/h	9,000	12,000	18,000
Min~Max Cooling BTU/h	3,100~12,000	3,100~13,600	3,100~20,100
Nominal Heating BTU/h	12,000	16,000	21,600
Min~Max Heating BTU/h	3,100~18,000	3,100~19,400	3,100~25,600
HSPF	13.0	12.2	11.5
SEER	24.0	21.9	20.1
EER Clg/Htg	14.5/13.5	12.8/11.1	11.2/12.3
Cooling Operating Range °F(°C)	14~115 (-10~46)	14~115 (-10~46)	14~115 (-10~46)
Heating Operating Range °F(°C)	-5~75 (-21~24)	-5~75 (-21~24)	-5~75 (-21~24)
Moisture Removal Pt./h(l/h)	1.3 (.06)	2.5 (1.2)	4.6 (2.2)
Voltage/Frequency/Phase	208-230/60/1	208-230/60/1	208-230/60/1
MAX.CRT.BKR (A)	15	15	20
Air Circ. C.F.M. (m <sup>3</sup> /h): Hi	318 (540)	359 (610)	400 (680) Clg
Medium	288 (490)	312 (530)	471 (800) Htg
Low	259 (440)	277 (470)	341 (580) Clg
Quiet	230 (390)	241 (410)	400 (680) Htg
Noise Level dB(A) Clg/Htg: Hi	33/34	37/37	288 (490) Clg
Medium	32/32	33/33	341 (580) Htg
Low	29/29	31/31	241 (410) Clg
Quiet	28/27	28/28	265 (450) Htg
Outdoor Fan Speed RPM Clg/Htg	590/720	870/780	1,050/1,000
Outdoor Noise Level Clg/Htg	48/49	49/50	54/55
Running Current Rated (A): Cooling	3.0	4.4	7.1
Heating	4.1	6.7	7.7
Power Use Rated/Max (kW): Clg	0.62/1.40	0.94/1.45	1.61/2.15
Heating	0.89/1.80	1.44/2.00	1.76/2.60
Fan Speeds Stage	4+auto	4+auto	4+auto
Air Direction: Vertical	Automatic	Automatic	Automatic
Air Filter	Washable	Washable	Washable
Front Grille	UTG-CCGF*	UTG-CCGF*	UTG-CCGF*
Connection Method	Flare	Flare	Flare
Conn. Pipe Diameter Inch	suc 3/8 dis 1/4	suc 3/8 dis 1/4	suc 1/2 dis 1/4
Combined Min. Length Ft (m)	10 (3)	10 (3)	10 (3)
Combined Max. Length Ft (m)	66 (20) (pre-charge: 49')	66 (20) (pre-charge: 49')	66 (20) (pre-charge: 49')
Max. Vertical Diff. Ft (m)	49 (15)	49 (15)	49 (15)
Indoor Unit Net Weight lbs. (kg)	33 (15)	33 (15)	33 (15)
Outdoor Unit Net Weight lbs. (kg)	84 (38)	84 (38)	86 (39)
Indoor Unit Dim: Height Inch (mm)	9-11/16 (245)	9-11/16 (245)	9-11/16 (245)
Width Inch (mm)	22-7/16 (570)	22-7/16 (570)	22-7/16 (570)
Depth Inch (mm)	22-7/16 (570)	22-7/16 (570)	22-7/16 (570)
Grille Dim: Height Inch (mm)	1-15/16 (49)	1-15/16 (49)	1-15/16 (49)
Width Inch (mm)	27-9/16 (700)	27-9/16 (700)	27-9/16 (700)
Depth Inch (mm)	27-9/16 (700)	27-9/16 (700)	27-9/16 (700)
Outdoor Unit Dim: Height Inch (mm)	24-1/2 (620)	24-1/2 (620)	24-1/2 (620)
Width Inch (mm)	31-3/32 (790)	31-3/32 (790)	31-3/32 (790)
Depth Inch (mm)	11-11/32 (290)	11-11/32 (290)	11-11/32 (290)
Refrigerant	R410A	R410A	R410A

\* Compact Cassette Grille UTG-CCGF sold separately. Must order one with each compact cassette.

Note: Figures are based on 230 Volts.



Systems 9RLFCC, 12RLFCC

# Ceiling Cassette Systems

SYSTEMS 18RCLX, 24RCLX, 36RCLX, 42RCLX



**Up to 16.0 SEER**

## Function

Up to 16-SEER, these models provide up to 30% increase in efficiency over 13-SEER models. These models offer the ability to send up to 38% of their capacity through two branch ducts to adjacent rooms. Slender fit feature now offered on all models decreases space required above the ceiling increasing application opportunities.

## Standard Features

- Weekly Timer
- Dry Mode
- Auto Louver: Up/ Down
- Auto Mode
- Energy Saver
- Auto Restart/Reset
- Auto Changeover
- 0°F Ambient Cooling
- Long Piping Length
- Cold Prevention
- Slender Fit
- Remote Temp. Sensor
- Daisy Chain
- Pump Down Operation
- High Ceiling Mode
- Branch Duct Capable
- Built-in Condensate Pump
- Fresh Air Intake\*

## Standard Wired Remote

- Weekly timer
- Set on-off time twice a day
- Set different on-off time by day
- Set time in 5 minute intervals
- Control up to 16 indoor units
- Child lock capable
- Remote temperature sensor

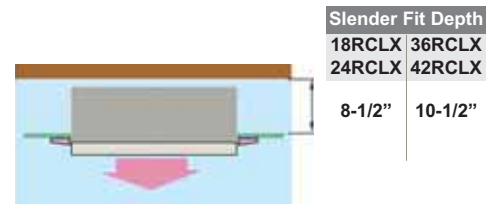
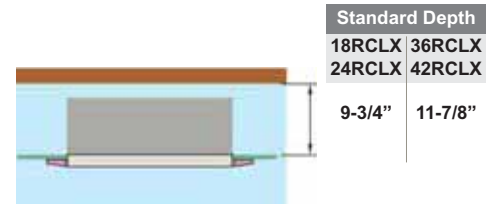

## Slender Fit

Cassette body can be moved downward into the room 1-3/8" to accommodate limited ceiling space.

## Applications

Four-way airflow, concealed flush mount design and the ability to operate in high ceiling rooms makes these systems ideal for commercial applications such as offices, conference rooms, restaurants, night clubs and bars in retrofit and new construction. Long maximum combined piping lengths of 165 to 230 feet with 60 to 98 feet of height, depending on model, allow the outdoor unit to be remotely located up to 7 stories away and far from indoor unit. The ceiling cassettes are also used in new construction condominiums and homes taking advantage of their branch duct capability to feed adjacent rooms. These heat pumps provide up to 30% additional available heat when compared to conventional models.

\*Fresh air knockout available. Fresh air fan and ductwork field supplied. See design and technical manual for details. Fujitsu fresh air intake kit available part #KHRS940-25.



**Fujitsu provides knock-outs on all ceiling cassettes where contractors can:**

- Install optional field supplied branch ducts on up to two sides to supply up to 18% capacity per side to adjoining spaces up to 16 feet away. See Design and Technical Manual for details.
- Allows fresh air to be brought into the indoor unit using fresh air knockout.

	18RCLX		24RCLX		36RCLX		42RCLX	
	Heat Pump		Heat Pump		Heat Pump		Heat Pump	
Nominal Cooling BTU/h	17,800		22,200		34,100		42,700	
Min.~Max. Cooling BTU/h	5,000~21,500		5,000~27,300		8,500~36,000		13,700~45,000	
Nominal Heating BTU/h	21,000		24,200		36,000		45,200	
Low Temp. Heating 17°F BTU/h	11,300		14,600		23,000		28,200	
Min.~Max. Heating BTU/h	5,000~25,600		5,000~29,000		9,200~42,700		14,300~54,600	
HSPF BTU/hW	8.5		8.5		8.5		8.5	
SEER BTU/hW	16.0		15.0		14.0		15.0	
EER Clg/Htg	11.1 / 10.2		10.6 / 10.2		8.1 / 9.7		9.2 / 10.5	
Clg. Operating Range °F(°C)	0~115 (-18~46)		0~115 (-18~46)		0~115 (-18~46)		0~115 (-18~46)	
Htg. Operating Range °F(°C)	14~75 (-10~24)		14~75 (-10~24)		14~75 (-10~24)		0~75 (-18~24)	
Moisture Removal Pt./h(l/h)	5.3 (2.5)		6.4 (3.0)		8.5 (4.0)		11.6 (5.5)	
Voltage/Frequency/Phase	208-230/60/1		208-230/60/1		208-230/60/1		208-230/60/1	
MAX.CRT.BKR (A)	20		20		30		30	
Air Circ. C.F.M. (m <sup>3</sup> /h): Hi	559 (950)		618 (1,050)		942 (1,600)		1,000 (1,700)	
Medium	477 (810)		536 (910)		824 (1,400)		854 (1,450)	
Low	394 (670)		436 (740)		677 (1,150)		736 (1,250)	
Noise Level dB(A): Hi	42/40 (Clg/Htg)		45/43 (Clg/Htg)		48/48 (Clg/Htg)		50/50 (Clg/Htg)	
Medium	39/38 (Clg/Htg)		43/39 (Clg/Htg)		45/45 (Clg/Htg)		48/48 (Clg/Htg)	
Low	36/36 (Clg/Htg)		38/35 (Clg/Htg)		41/41 (Clg/Htg)		44/44 (Clg/Htg)	
Outdoor Fan Speed RPM	780/780		850/900		850/900		850/750	
Outdoor Noise Level dB(A)	51/53 (Clg/Htg)		53/55 (Clg/Htg)		54/55 (Clg/Htg)		55/56 (Clg/Htg)	
Current Rated/Max (A): Cooling	7.0/12.5		9.2/12.5		18.3/18.8		20.3/21.7	
Heating	8.9/12.5		10.4/12.5		16.1/18.8		18.8/21.7	
Power Use Rated/Max (kw): Clg	1.61/2.88		2.10/2.88		4.22/4.35		4.66/4.99	
Heating	2.05/2.88		2.37/2.88		3.70/4.35		4.31/4.99	
Fan Speeds Stage	3 + Auto		3 + Auto		3 + Auto		3 + Auto	
Air Direction: Horizontal	-		-		-		-	
Vertical	Automatic		Automatic		Automatic		Automatic	
Air Filter	Washable		Washable		Washable		Washable	
Front Grille	Removable		Removable		Removable		Removable	
Connection Method	Flare		Flare		Flare		Flare	
Combined Min. Lgth Ft (m)	16 (5)		16 (5)		16 (5)		16 (5)	
Combined Max. Lgth Ft (m)	165 (50) Each (pre-charge: 49')		165 (50) Each (pre-charge: 49')		165 (50) Each (pre-charge: 49')		230 (70) Each (pre-charge: 66')	
Max. Vertical Diff. Ft (m)	66 (20)		66 (20)		98 (30)		230 (70)	
Conn. Pipe Diameter Inch	Suc. 1/2	Dis. 1/4	Suc. 5/8	Dis. 3/8	Suc. 5/8	Dis. 3/8	Suc. 5/8	Dis. 3/8
Net Weight lbs. (kg)	75 (34)	141 (64)	75 (34)	141 (64)	82 (37)	141 (64)	88 (40)	231 (105)
Dimensions: Height Inch	9-3/4	32-3/4	9-3/4	32-3/4	11-5/8	32-3/4	11-5/8	50-7/8
mm	246	830	246	830	296	830	296	1290
Width Inch	32-3/4	35-1/2	32-3/4	35-1/2	32-3/4	35-1/2	32-3/4	35-1/2
mm	830	900	830	900	830	900	830	900
Depth Inch	32-3/4	13	32-3/4	13	32-3/4	13	32-3/4	13
mm	830	330	830	330	830	330	830	330
Refrigerant	R410A		R410A		R410A		R410A	
	Indoor AUU18RCLX	Outdoor AOU18RLX	Indoor AUU24RCLX	Outdoor AOU24RLX	Indoor AUU36RCLX	Outdoor AOU36RLX	Indoor AUU42RCLX	Outdoor AOU42RLX

Note: Figures are based on 230 Volts.



# MULTI ZONE MINI-SPLIT SYSTEMS

*Revolutionary Halcyon  
HFI systems are changing  
the way we define comfort*

- Operate as few as one indoor unit or all indoor units
- Choose from 4 indoor unit styles - wall mount including new RLF1 models and Designer Series RLS2 models, slim duct, compact cassette, and floor mount
- Four combinations are ENERGY STAR® qualified
- Create over 56,000 combinations based on indoor type and BTU



- Connect 2 to 4 indoor units, depending on model
- Connect 14,000 to 39,000 BTU
- No branch boxes or separation tubes required



- Connect 2 to 8 indoor units
- 80 to 130% connectable capacity
- Connect 39,000 to 62,000 BTU
- Branch boxes and separation tubes required





# Multi-Zone Outdoor Units 18, 24 and 36,000 BTUs

AOU18RLXFZ, AOU24RLXFZ, AOU36RLXFZ



## Part of the Halcyon Hybrid Flex Inverter (HFI) Line

As part of the Halcyon HFI line of equipment, select indoor units are compatible with other HFI outdoor units, meaning mix and match capabilities with fewer components.

### Connectable Capacity

This function allows you to connect indoor units that can exceed outdoor unit capacity (See sizing guide on page 39 for details). However, if you connect indoor units that exceed 100% of the outdoor unit's capacity there are limitations.

If all indoor units are cooling or heating at the same time, the system will limit their capacity so that their total matches the outdoor unit's capacity. When a zone meets a desired set temperature it requires less capacity. The unused capacity is then distributed to the remaining indoor units, increasing their capacity.

### For Example

The load on a 3-bedroom home with a living room and kitchen downstairs and 3 bedrooms upstairs is 39,000 BTUs (21,000 BTU downstairs and 18,000 BTU upstairs). However the family isn't upstairs and downstairs at the same time, therefore not all units will be running simultaneously allowing 100% heating or cooling to occupied spaces. This can be achieved by our AOU36RLXFZ outdoor unit.

# Flex Zone Outdoor Unit 48,000 BTUs

AOU48RLXFZ1



Halcyon HFI Flex Zone system's zoning capability allows you to set each indoor unit to a different temperature - that means you can set up to 8 different temperatures as needed! This system provides individual temperature control throughout your home or business so each room, zone or floor will be the temperature you set! An optional Central Remote Control is available which can control up to all 8 indoor units from one keypad. Additionally, you can set timers - 24-hour timer and sleep timer - for your convenience.

### 130% Connectable Capacity

The HFI system is rated at 48,000 BTUs but you can connect up to 130%, or 62,000 BTUs of rated indoor unit capacity to the AOU48RLXFZ1. Connectable capacity allows you to connect indoor units that can exceed outdoor unit capacity (See sizing guide on page 42 for details). However, if you connect indoor units that exceed 100% of the outdoor unit's capacity there are limitations.

If all indoor units are cooling or heating at the same time, the system will limit their capacity so that their total matches the outdoor unit's capacity. When a zone meets a desired set temperature it requires less capacity. The unused capacity is then distributed to the remaining indoor units, increasing their capacity.

### For Example

The load on a small 2-story office building with a business downstairs and worker apartments upstairs is 62,000 BTUs (38,000 BTUs downstairs and 24,000 BTUs upstairs) but the workers aren't upstairs and downstairs at the same time, therefore not all units will be running simultaneously allowing 100% heating or cooling to occupied spaces.



# Mix and Match Flexibility



AOU18RLXFZ



AOU24RLXFZ



AOU36RLXFZ



AOU48RLXFZ1

The ability to create the **right combinations**, the **right quantity** (up to 8-zones), the **right style indoor units**, and the **right capacity**.

It's the **RIGHT choice** for your home or business.

## Wall Mounts



ASU7, 9, 12RLF1



ASU9, 12RLS2



ASU15RLS2



ASU18RLF



ASU24RLF



## Slim Ducts



ARU7, 9, 12RLF



ARU18RLF



ARU24RLF



## Floor Mounts



AGU9, 12RLF



AGU15RLF



## Separation Tubes, Branch Boxes

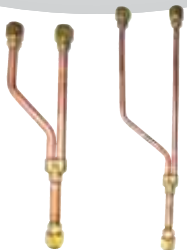

UTP-SX248A



UTP-PU03A, UTP-PU03B



## Compact Cassettes



AAU7, 9, 12RLF



AAU18RLF



# Wall Mounted 7, 9, 12, 18 and 24,000 BTUs



ASU7RLF1, ASU9RLF1, ASU9RLS2, ASU12RLF1, ASU12RLS2, ASU15RLS2, ASU18RLF, ASU24RLF **NEW!**



ASU7, 9, 12RLF1



ASU18, 24RLF



ASU9, 12, 15RLS2

						Designer Series			
	ASU7RLF1	ASU9RLF1	ASU12RLF1	ASU18RLF	ASU24RLF	ASU9RLS2	ASU12RLS2	ASU15RLS2	
	Heat Pump <b>NEW!</b>	Heat Pump <b>NEW!</b>	Heat Pump <b>NEW!</b>	Heat Pump	Heat Pump	Heat Pump*	Heat Pump*	Heat Pump*	
Nominal Cooling BTU/h	7,000	9,000	12,000	18,000	24,000	9,000	12,000	14,000	
Nominal Heating BTU/h	8,100	10,200	13,500	20,000	27,000	10,200	13,500	16,300	
Voltage/Frequency/Phase	208-230/60/1	208-230/60/1	208-230/60/1	208-230/60/1	208-230/60/1	208-230/60/1	208-230/60/1	208-230/60/1	
Air Circ. C.F.M. (m³/h): Hi	Clg 330 (560) Htg 330 (560)	Clg 353 (600) Htg 353 (600)	Clg 388 (660) Htg 388 (660)	Clg 542 (920) Htg 542 (920)	Clg 659 (1,120) Htg 647 (1,100)	Clg 353 (600) Htg 353 (600)	Clg 388 (660) Htg 388 (660)	Clg 418 (710) Htg 418 (710)	
	Medium	Clg 294 (500) Htg 294 (500)	Clg 306 (520) Htg 306 (520)	Clg 330 (560) Htg 330 (560)	Clg 436 (740) Htg 436 (740)	Clg 530 (900) Htg 530 (900)	Clg 324 (550) Htg 324 (550)	Clg 353 (600) Htg 353 (600)	Clg 377 (640) Htg 377 (640)
Low	Clg 253 (430) Htg 253 (430)	Clg 253 (430) Htg 253 (430)	Clg 265 (450) Htg 277 (470)	Clg 365 (620) Htg 365 (620)	Clg 436 (740) Htg 436 (740)	Clg 277 (470) Htg 277 (470)	Clg 312 (530) Htg 312 (530)	Clg 336 (570) Htg 347 (590)	
	Quiet	Clg 182 (310) Htg 194 (330)	Clg 182 (310) Htg 194 (330)	Clg 182 (310) Htg 194 (330)	Clg 324 (550) Htg 324 (550)	Clg 365 (620) Htg 365 (620)	Clg 194 (330) Htg 194 (330)	Clg 194 (330) Htg 194 (330)	Clg 230 (390) Htg 253 (430)
Noise Level dB(A) (Clg/Htg): Hi	36/36	37/37	40/40	43/44	49/48	36/36	37/37	41/41	
	Medium	32/32	33/33	36/36	37/37	32/32	34/34	36/36	
	Low	29/29	29/29	30/31	33/33	37/37	28/28	31/31	33/34
	Quiet	21/22	21/22	21/22	31/31	33/33	21/21	21/21	25/27
Running Current Rated (A): Cooling	0.13	0.15	0.19	0.32	0.53	0.14	0.17	0.20	
	Heating	0.13	0.15	0.19	0.32	0.53	0.14	0.17	0.20
Power Use Rated (W): Clg	15	17	22	41	69	16	19	23	
	Htg	15	17	22	41	69	16	19	23
Fan Speeds Stage	4+auto	4+auto	4+auto	4+auto	4+auto	4+auto	4+auto	4+auto	
Air Direction: Horizontal	Manual	Manual	Manual	Auto	Auto	Manual	Manual	Manual	
	Vertical	Auto	Auto	Auto	Auto	Auto	Auto	Auto	
Primary Air Filter	Washable	Washable	Washable	Washable	Washable	Washable	Washable	Washable	
Ion Deodorizing Filter	Disposable	Disposable	Disposable	Disposable	Disposable	Disposable	Disposable	Disposable	
Apple-Catechin Filter	Disposable	Disposable	Disposable	Disposable	Disposable	Disposable	Disposable	Disposable	
Connection Method	Flare	Flare	Flare	Flare	Flare	Flare	Flare	Flare	
Conn. Pipe Diameter Inch	suc 3/8 dis 1/4	suc 3/8 dis 1/4	suc 3/8 dis 1/4	suc 1/2 dis 1/4	suc 5/8 dis 1/4	suc 3/8 dis 1/4	suc 3/8 dis 1/4	suc 1/2 dis 1/4	
Net Weight lbs. (kg)	19 (8.5)	19 (8.5)	19 (8.5)	31 (14)	31 (14)	21 (9.5)	21 (9.5)	21 (9.5)	
Dims: Height Inch (mm)	10-1/2 (268)	10-1/2 (268)	10-1/2 (268)	12-5/8 (320)	12-5/8 (320)	11-1/8 (282) 13-1/4* (337*)	11-1/8 (282) 13-1/4* (337*)	11-1/8 (282) 13-1/4* (337*)	
	Width Inch (mm)	33-1/16 (840)	33-1/16 (840)	33-1/16 (840)	39-1/4 (998)	39-1/4 (998)	34-1/4 (870)	34-1/4 (870)	34-1/4 (870)
Depth Inch (mm)	8 (203)	8 (203)	8 (203)	9 (228)	9 (228)	7-1/4 (185)	7-1/4 (185)	7-1/4 (185)	
Refrigerant	R410A	R410A	R410A	R410A	R410A	R410A	R410A	R410A	

\* ESP feature not compatible in multi-zone configurations. ^Height when front panel is open.

## Standard Features

- Wireless Remote Control\*
- Apple Catechin Filter
- Ion Deodorizing Filter
- Sleep Timer
- 24-Hour Timer
- Dry Mode
- Auto Louver: 4-Way\*\*
- Auto Mode
- Minimum Heat Mode
- Auto Restart/Reset
- Power Diffuser\*\*

## Built In Filtration



### Long-life\* Ion Deodorization Filter

The filter deodorizes by powerfully decomposing absorbed odors using the oxidizing and reducing effects of ions generated by the ultra-fine-particle ceramic.

+ The filter can be used for approximately 3 years if it is washed with water when dirty to restore its surface action.



### Apple-Catechin Filter

Dust, mold spores and micro-organisms are absorbed onto the filter by static electricity and growth is inhibited and deactivated.

\* Features vary by model and therefore standard wireless remote controls should be used with the models they are associated with.

\*\* Feature of models ASU18, 24RLF only.

# Slim Duct 7, 9, 12, 18 and 24,000 BTUs



## ARU7RLF, 9RLF, ARU12RLF, ARU18RLF, ARU24RLF



### Flexible Installation

Horizontal or vertical\*.

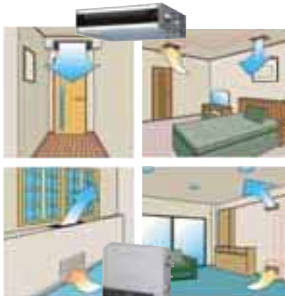

\*Internal drain pump will not operate when the unit is mounted in a vertical configuration.

### Slim Duct

Adaptable when ceiling cavity is small and there is no slope for drain.

#### Traditional



#### Slim Duct



	ARU7RLF	ARU9RLF	ARU12RLF	ARU18RLF	ARU24RLF
Heat Pump	Heat Pump	Heat Pump	Heat Pump	Heat Pump	Heat Pump
	<b>NEW!</b>				
Nominal Cooling BTU/h	7,000	9,000	12,000	18,000	24,000
Nominal Heating BTU/h	8,100	10,200	13,500	20,000	27,000
Voltage/Frequency/Phase	208-230/60/1	208-230/60/1	208-230/60/1	208-230/60/1	208-230/60/1
Static Pressure In. W. C.	0 ~ 0.36	0 ~ 0.36	0 ~ 0.36	0 ~ 0.36	0 ~ 0.20
Air Circ. C.F.M. (m <sup>3</sup> /h) Clg/Htg: Hi	323 (550)	353 (600)	383 (650)	554 (940)	783 (1,330)
Medium	288 (490)	324 (550)	353 (600)	518 (880)	730 (1,240)
Low	276 (470)	294 (500)	324 (550)	483 (820)	648 (1,100)
Quiet	259 (440)	265 (450)	283 (480)	442 (750)	607 (1,030)
Noise Level dB(A) (Clg/Htg): Hi	28/28	28/28	29/29	32/33	33/35
Medium	26/26	27/26	28/28	31/32	32/34
Low	25/25	26/25	27/27	30/31	30/32
Quiet	24/24	25/24	26/24	29/29	29/29
Running Current Rated (A): Cooling	0.30	0.30	0.35	0.44	0.66
Heating	0.30	0.30	0.35	0.44	0.66
Power Use Rated (W): Cooling	33	49	58	73	111
Heating	33	49	58	73	111
Fan Speeds Stage	4 + Auto	4 + Auto	4 + Auto	4 + Auto	4 + Auto
Air Filter	Washable	Washable	Washable	Washable	Washable
Connection Method	Flare	Flare	Flare	Flare	Flare
Conn. Pipe Diameter Inch	suc 3/8 dis 1/4	suc 3/8 dis 1/4	suc 3/8 dis 1/4	suc 1/2 dis 1/4	suc 5/8 dis 1/4
Net Weight lbs. (kg)	37 (17)	41 (19)	41 (19)	50 (23)	59 (27)
Dimensions: Height Inch (mm)	7-25/32 (198)	7-25/32 (198)	7-25/32 (198)	7-25/32 (198)	7-25/32 (198)
Width Inch (mm)	27-9/16 (700)	27-9/16 (700)	27-9/16 (700)	35-7/16 (900)	43-5/16 (1,100)
Depth Inch (mm)	24-13/32 (620)	24-13/32 (620)	24-13/32 (620)	24-13/32 (620)	24-13/32 (620)
Supply Duct Flange					
Dimensions: Height Inch (mm)	5-15/16 (151)	5-15/16 (151)	5-15/16 (151)	5-15/16 (151)	5-15/16 (151)
Width Inch (mm)	25-19/32 (650)	25-19/32 (650)	25-19/32 (650)	33-15/32 (850)	41-11/32 (1,050)
Depth Inch (mm)	3/4 (19)	3/4 (19)	3/4 (19)	3/4 (19)	3/4 (19)
Return Duct					
Dimensions: Height Inch (mm)	6 (152)	6 (152)	6 (152)	6 (152)	6 (152)
Width Inch (mm)	22 (559)	22 (559)	22 (559)	30 (762)	37-3/4 (959)
Depth Inch (mm)	3/4 (19) (Flat)	3/4 (19) (Flat)	3/4 (19) (Flat)	3/4 (19) (Flat)	3/4 (19) (Flat)
Refrigerant	R410A	R410A	R410A	R410A	R410A

### Standard Features

- Dry Mode
- Weekly Timer
- Sleep Timer\*
- 24-Hour Timer\*
- Minimum Heat Mode\*
- Auto Mode
- Quiet Mode
- Auto Restart/Reset
- Auto Changeover
- Condensate Pump
- Fresh Air Intake

\*Available only with optional wireless remote control.

### Field Supplied Filters

Filters are sized to keep velocities and static pressure loss low. This will insure sufficient static pressure is available for ductwork, fittings and supply and return grilles. Alternative filter sizes with equivalent face areas can be used.

	ARU 7RLF	ARU 9RLF	ARU 12RLF	ARU 18RLF	ARU 24RLF
CFM	323	353	383	554	785
Typical Filter Size	12 x 20	12 x 20	12 x 20	14 x 25	18 x 30
Velocity, FPM	194	212	230	228	209
Unit External SP, in. W.C.	0.36	0.36	0.36	0.36	0.20
<b>1" Fiberglass Filter</b>					
SP Loss, in. W.C.	0.04	0.04	0.05	0.04	0.04
Available Static Pressure	0.32	0.32	0.31	0.32	0.16
<b>1" MERV 8 Pleated Filter</b>					
SP Loss, in. W.C.	0.10	0.12	0.14	0.14	0.12
Available Static Pressure	0.26	0.24	0.22	0.22	0.08
<b>2" MERV 8 Pleated Filter</b>					
SP Loss, in. W.C.	0.06	0.07	0.08	0.08	0.07
Available Static Pressure	0.30	0.29	0.28	0.28	0.13

# Compact Cassettes 7, 9, 12, and 18,000 BTUs

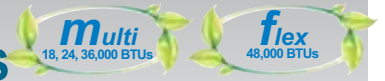

## AUU9RLF, AUU12RLF, AUU18RLF



### Easy Installation

Fits into a standard ceiling tile\*.



\*Dimensions of outer grille are 27-9/16" x 27-9/16" and may overlap adjacent tiles.

### 2-Stage Turbo Fan

Air distribution is evenly spread across the heat exchanger by the new 2 stage turbo fan which produces two separate airflow streams.

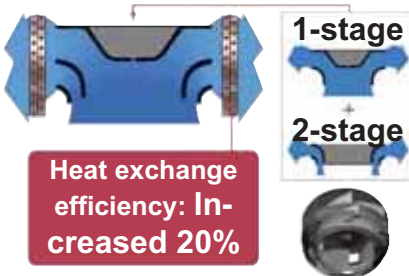

### Standard Features

- Sleep Timer
- Dry Mode
- Auto Louver: Up/ Down
- Quiet Mode
- Auto Restart/Reset
- Auto Changeover
- Remote Temperature Sensor
- High Ceiling Mode
- Condensate Pump
- 2-Stage Turbo Fan
- Minimum Heat Mode+
- Fresh Air Intake\*\*

	AUU7RLF	AUU9RLF	AUU12RLF	AUU18RLF
Heat Pump	Heat Pump	Heat Pump	Heat Pump	Heat Pump
	<b>NEW!</b>			
Nominal Cooling BTU/h	7,000	9,000	12,000	18,000
Nominal Heating BTU/h	8,100	10,200	13,500	20,000
Voltage/Frequency/Phase	208-230/60/1	208-230/60/1	208-230/60/1	208-230/60/1
Air Circ. C.F.M. (m <sup>3</sup> /h): Hi	318 (540) Clg or Htg 288 (490)	318 (540) Clg or Htg 288 (490)	359 (610) Clg or Htg 312 (530)	441 (750) Clg 471 (800) Htg 359 (610) Clg
Medium	Clg or Htg 259 (440)	Clg or Htg 259 (440)	Clg or Htg 277 (470)	418 (710) Htg 306 (520) Clg
Low	Clg or Htg 230 (390)	Clg or Htg 230 (390)	Clg or Htg 241 (410)	353 (600) Htg 241 (410) Clg
Quiet	Clg or Htg 33/34	Clg or Htg 33/34	Clg or Htg 37/37	265 (450) Htg 42/44
Noise Level dB(A) Clg/Htg: Hi	31/32	31/32	33/33	37/40
Medium	29/29	29/29	31/31	33/37
Low	27/27	27/27	28/28	29/30
Quiet	0.15	0.15	0.19	0.30
Running Current Rated (A): Cooling	0.15	0.15	0.19	0.30
Heating	0.15	0.15	0.19	0.30
Power Use Rated/Max (W): Clg	18	18	23	39
Heating	18	18	23	39
Fan Speeds Stage	4+auto	4+auto	4+auto	4+auto
Air Direction: Vertical	Automatic	Automatic	Automatic	Automatic
Air Filter	Washable	Washable	Washable	Washable
Front Grille	UTG-CCGF*	UTG-CCGF*	UTG-CCGF*	UTG-CCGF*
Connection Method	Flare	Flare	Flare	Flare
Conn. Pipe Diameter Inch	suc 3/8 dis 1/4	suc 3/8 dis 1/4	suc 3/8 dis 1/4	suc 1/2 dis 1/4
Net Weight lbs. (kg)	33 (15)	33 (15)	33 (15)	33 (15)
Chassis Dim: Height Inch (mm)	9-11/16 (245)	9-11/16 (245)	9-11/16 (245)	9-11/16 (245)
Width Inch (mm)	22-7/16 (570)	22-7/16 (570)	22-7/16 (570)	22-7/16 (570)
Depth Inch (mm)	22-7/16 (570)	22-7/16 (570)	22-7/16 (570)	22-7/16 (570)
Grille Dim: Height Inch (mm)	1-15/16 (49)	1-15/16 (49)	1-15/16 (49)	1-15/16 (49)
Width Inch (mm)	27-9/16 (700)	27-9/16 (700)	27-9/16 (700)	27-9/16 (700)
Depth Inch (mm)	27-9/16 (700)	27-9/16 (700)	27-9/16 (700)	27-9/16 (700)
Refrigerant	R410A	R410A	R410A	R410A

+ Available only with optional wireless remote control.  
 \*\*Requires Fujitsu's Optional Fresh Air Kit part #UTZ-VXAA. Allows for a 4-inch flex duct connection and a field supplied duct booster fan. Fresh air maximum is 10% of unit High fan CFM. See UTZ-VXAA Design and Technical Manual for fan static pressure requirements at Fresh Air Kit. Add hood, filter and duct losses for fan total static pressure requirements. Will add 4" to the height of the indoor unit.  
 \* Compact Cassette Grille UTG-CCGF sold separately. Must order one with each compact cassette.



**Fresh Air Kit\*\*  
UTZ-VXAA**  
Mixes room air then passes through the heat exchanger.



# Floor Mount 9, 12, and 15,000 BTUs



## AGU9RLF, AGU12RLF, AGU15RLF



### 2-Fan and Wide Airflow

Having both upper and lower airflow quickly warms or cools the entire room. Floor mount can be set in "Upward Airflow Only" when occupants wish not to have feet warmed or cooled.



### Flexible and Easy Installation

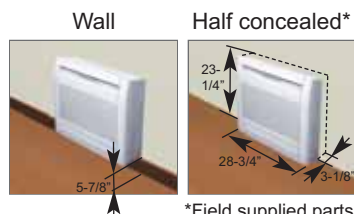
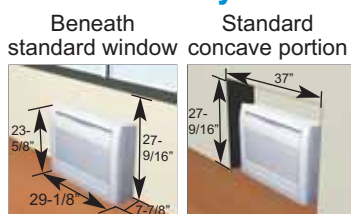

\*Field supplied parts required

### Standard Features

- Wireless Remote Control
- Apple Catechin Filter
- Ion Deoderizing Filter
- Sleep Timer
- 24-Hour Timer
- Auto Louver: Up/Down
- Auto Mode
- Minimum Heat Mode
- Economy Mode
- Auto Restart/Reset
- Auto Changeover
- Powerful Mode



Designer wireless remote control

### AGU9RLF AGU12RLF AGU15RLF

	Heat Pump <b>NEW!</b>	Heat Pump <b>NEW!</b>	Heat Pump <b>NEW!</b>
Nominal Cooling <i>BTU/h</i>	9,000	12,000	14,200
Nominal Heating <i>BTU/h</i>	12,000	16,000	18,000
Voltage/Frequency/Phase	208-230/60/1	208-230/60/1	208-230/60/1
Air Circ. <i>C.F.M. (m<sup>3</sup>/h)</i> : Hi	312 (530)	353 (600)	383 (650)
Medium	259 (440)	288 (490)	306 (520)
Low	212 (360)	224 (380)	235 (400)
Quiet	159 (270)	159 (270)	159 (270)
Noise Level <i>dB(A)Clg/Htg</i> : Hi	39/39	42/42	44/44
Medium	34/34	36/38	38/39
Low	28/28	30/32	31/33
Quiet	22/22	22/22	22/22
Running Current <i>Rated (A)</i> : Cooling	0.15	0.18	0.20
Heating	0.15	0.18	0.20
Power Use <i>Rated (W)</i> : Cooling	16	18	23
Heating	16	18	23
Fan Speeds <i>Stage</i>	4+Auto	4+Auto	4+Auto
Air Direction: <i>Horizontal</i>	Manual	Manual	Manual
<i>Vertical</i>	Auto	Auto	Auto
Air Filter	Washable	Washable	Washable
Apple Catechin Filter	Yes	Yes	Yes
Ion Deoderizing Filter	Yes	Yes	Yes
Connection Method	Flare	Flare	Flare
Conn. Pipe Diameter <i>Inch</i>	Suc. 3/8 Dis. 1/4	Suc. 3/8 Dis. 1/4	Suc. 1/2 Dis. 1/4
Net Weight <i>lbs. (kg)</i>	31 (14)	31 (14)	31 (14)
Dimensions: Height <i>Inch</i>	23-5/8	23-5/8	23-5/8
<i>mm</i>	600	600	600
Width <i>Inch</i>	29-1/8	29-1/8	29-1/8
<i>mm</i>	740	740	740
Depth <i>Inch</i>	7-7/8	7-7/8	7-7/8
<i>mm</i>	200	200	200
Refrigerant	R410A	R410A	R410A



# Multi Zone Outdoor Units 18, 24 and 36,000 BTUs

**AOU18RLXFZ, AOU24RLXFZ,  
AOU36RLXFZ**



**AOU18, 24RLXFZ**

**AOU36RLXFZ**



## Compact Size

The compact size of the outdoor units allows for many installation opportunities.

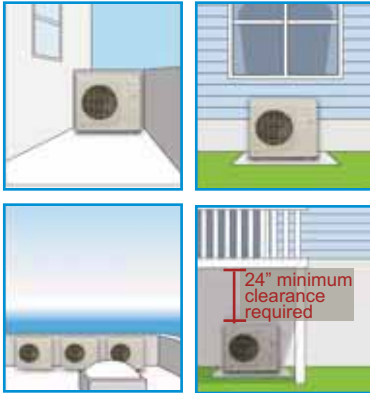

## DC Twin Rotary Compressor

A high performance, low noise, large capacity DC twin rotary compressor is used.



## Nominal Capacities, SEER and HSPF Ratings

Data below is based on AHRI 210/240 non-ducted wall mounted models.

Connectable Indoor Unit *Number*  
 Connectable Unit Capacity Class *BTU/h*  
 Rated Capacity Cooling/Heating *BTU/h*  
 Clg. Operating Range °F(°C)  
 Htg. Operating Range °F(°C)  
 Input Power: Clg/Htg Rated *kW\**  
 Voltage/Frequency/Phase  
 Current: Total Max. (A)  
 Minimum Circuit Ampacity (A)  
 MAX.CRT.BKR (A)  
 Outdoor Fan Airflow *CFM (Clg/Htg)*  
 Fan: Type x Quantity  
 Sound Pressure Level Cooling *dB(A)*  
 Sound Pressure Level Heating *dB(A)*  
 Pre-Charge Length Total *Ft (m)*  
 Max. Length Total *Ft (m)*  
 Max. Length Each *Ft (m)*  
 Min. Length Total *Ft (m)*  
 Min. Length Each *Ft (m)*  
 Max. Pipe Height Difference Between Outdoor Unit & Farthest Indoor *Ft (m)*  
 Max. Pipe Height Difference Between Indoor Units *Ft (m)*  
 Connection Method

Conn. Pipe Diameter *Inch*  
 Net Weight *lbs. (kg)*  
 Dimensions: Height *Inch mm*  
 Width *Inch mm*  
 Depth *Inch mm*  
 Refrigerant

AOU 18RLXFZ	AOU 24RLXFZ	AOU 36RLXFZ	AOU 36RLXFZ
Heat Pump ASU9+ASU9	Heat Pump ASU9+ASU7+ASU7	Heat Pump ASU9 x 4	18+18 Combo ASU18+ASU18
2	2 to 3	3 to 4	2
14 to 21,000 <sup>2</sup>	14 to 27,000 <sup>2</sup>	27 to 39,000 <sup>2</sup>	36,000 <sup>1</sup>
18,000/22,000	22,000/24,000	35,200/36,400	31,600/35,800
14 to 115 (-10 to 46)	14 to 115 (-10 to 46)	32 to 115 (0 to 46)	50 to 115 (10 to 46)
5 to 75 (-15 to 24)	5 to 75 (-15 to 24)	14 to 75 (-10 to 24)	14 to 75 (-10 to 24)
1.44/1.87	1.76/1.73	4.00/3.00	3.98/3.66
208-230/60/1	208-230/60/1	208-230/60/1	208-230/60/1
10.0	13.7	20.1	20.1
13	17	25	25
25	25	30	30
1,795/1,619	1,942/1,942	2,119/2,237	2,119/2,237
Propeller x 1	Propeller x 1	Propeller x 1	Propeller x 1
49	51	53	53
49	52	55	55
98 (30)	98 (30)	164 (50)	66 (20)
164 (50)	164 (50)	230 (70)	131 (40)
82 (25)	82 (25)	82 (25)	82 (25)
49 (15)	49 (15)	66 (20)	49 (15)
16 (5)	16 (5)	16 (5)	25 (7.5)
49 (15)	49 (15)	49 (15)	49 (15)
33 (10)	33 (10)	33 (10)	33 (10)
Flare	Flare	Flare	Flare
Liq. 1/4 x 2 Suc. 3/8 x 2	Liq. 1/4 x 3 Suc. 1/2 x 1, 3/8 x 2	Liq. 1/4 x 4 Suc. 1/2 x 1, 3/8 x 3	Liq. 3/8 x 2 Suc. 1/2 x 2
119 (54)	124 (56)	149 (68)	149 (68)
27-9/16 700	27-9/16 700	32-11/16 830	32-11/16 830
35-7/16 900	35-7/16 900	35-7/16 900	35-7/16 900
13 330	13 330	13 330	13 330
R410A	R410A	R410A	R410A

<sup>1</sup>18+18 is the only 2 indoor unit (ASU, ARU or AAU) combination and requires K9FZ1818.  
<sup>2</sup>See table on page 46 for allowed combinations within this connectable capacity range.

Model	Indoor Unit		Cooling Capacity Btu/h	EER	SEER	Heating Capacity Btu/h		COP	HSPF
	Type	Combination				95 F	47 F		
AOU18RLXFZ	Non-Ducted	ASU9+ASU9	18,000	12.50	18.0	22,000	13,900	3.44	9.3
	Ducted	-	18,000	12.10	16.0	22,000	13,900	3.52	9.0
	Mixed	-	18,000	12.30	17.0	22,000	13,900	3.48	9.2
	Specific	ASU7+ASU12 and ASU9+ASU12	18,000	12.50	18.0	22,000	13,900	3.67	9.0
AOU24RLXFZ	Non-Ducted	ASU9+ASU7+ASU7	22,000	12.50	18.0	24,000	14,100	4.04	9.5
	Ducted	-	22,000	10.60	15.5	24,000	14,100	3.42	9.0
	Mixed	-	22,000	11.55	16.8	24,000	14,100	3.74	9.3
AOU36RLXFZ	Non-Ducted	-	35,200	8.80	16.0	36,400	22,000	3.56	9.4
	Ducted	-	33,800	8.10	14.5	36,400	21,200	3.08	8.7
	Mixed	-	34,400	8.45	15.3	36,400	21,600	3.32	9.1

Yellow rows represent models that are ENERGY STAR® qualified.

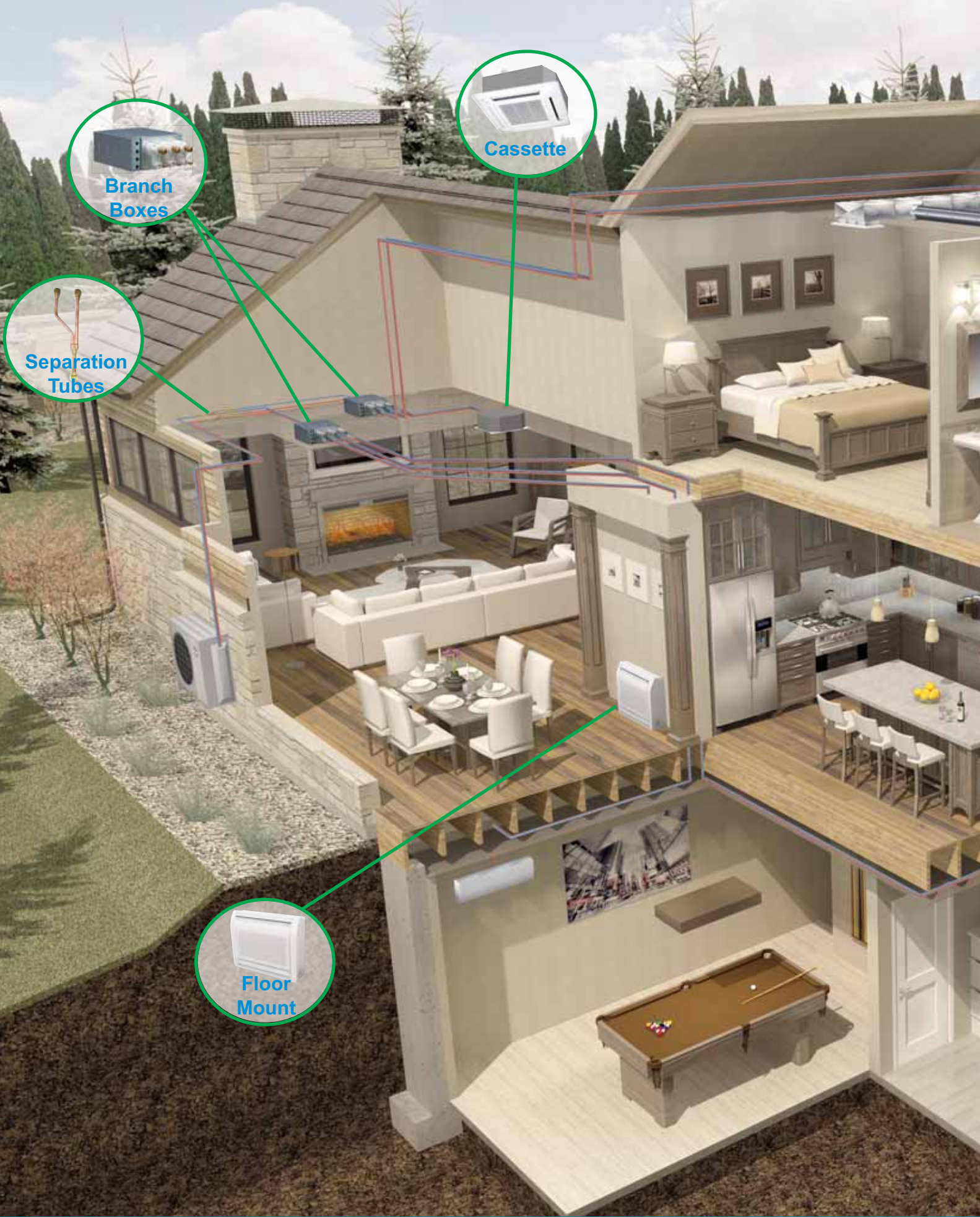





Slim Duct



Wall Mount



- Connect 2 to 8 indoor units
- 80 to 130% connectable capacity
- Connect 39,000 to 62,000 BTU
- Branch boxes and separation tubes required

***Cool or heat one room, a few rooms or an entire home.***

# Flex Zone Outdoor Unit 48,000 BTUs

**AOU48RLXFZ1**



- Connect 2 to 8 indoor units
- 80 to 130% connectable capacity
- Connect 39,000 to 62,000 BTU

**2 Indoor Units**

18k BTU/h + 24 k BTU/h = 42k BTU/h ··OK  
12k BTU/h + 24 k BTU/h = 36k BTU/h ··Not Allowed (below 80%)

**8 Indoor Units**

7k BTU/h × 8 units = 56k BTU ··OK  
9k BTU/h × 8 units = 72k BTU ··Not Allowed (over 130%)

## Compact Size

The compact size of outdoor unit AOU48RLXFZ1 allows for many installation opportunities.

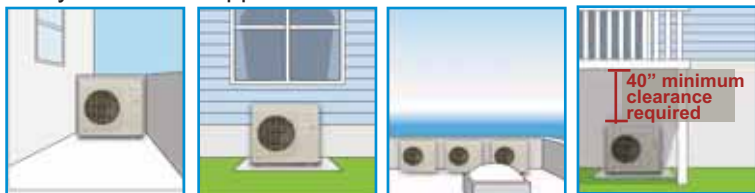

## Self Diagnostic Feature

This printed circuit board provides three modes of diagnostics - setting, monitoring and function mode, as well as error codes. It also provides a pre-commissioning check function. Setting mode allows optional functions to be selected. Monitoring mode provides temperature for each thermistor, compressor operation and other functions. Function mode provides cooling test run, heating test run and pump down operation.



## Piping Flexibility

Contractors can choose the best direction for piping from the outdoor unit.

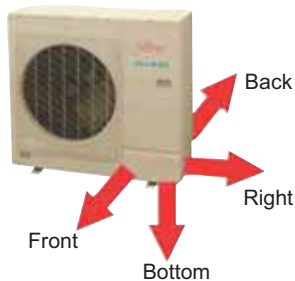

## DC Twin Rotary Compressor

A high performance, low noise, large capacity DC twin rotary compressor is used. Includes Quiet Mode for night operation.



### AOU48RLXFZ1 Heat Pump

Connectable Indoor Unit Number	2 to 8
Connectable Indoor Unit Capacity	80 to 130% Nominal (39,000 - 62,000 BTU)
Connectable Branch Box Number	1 to 3
Nominal Cooling BTU/h	48,000
Max Cooling BTU/h	51,100
Nominal Heating BTU/h	54,000
Low Temp. Heating 17°F BTU/h	40,000
Max Heating BTU/h	57,000
Clg. Operating Range °F(°C)	23-115 (-5-46)
Htg. Operating Range °F(°C)	5-75 (-15-24)
Input Power: Cooling Rated kW*	5.52 / 5.19 / 5.35
Input Power: Heating Rated kW*	5.02 / 4.89 / 4.96
Voltage/Frequency/Phase	208-230/60/1
Current: Clg Outdoor Max. (A)	24.5 / 23.0 / 23.7
Current: Htg Outdoor Max. (A)	22.3 / 21.7 / 22.0
MAX.CRT.BKR (A)	40
Outdoor Fan Speed RPM (Clg/Htg)	890/910
Fan: Type x Quantity	Propeller x 1
Fan Motor Output W	111
Sound Pressure Level Cooling dB(A)	56
Sound Pressure Level Heating dB(A)	58
Max. Pipe Length Total Ft (m)	377 (115)
Max. Pipe Length Between Box & Farthest Indoor Unit Ft (m)	49 (15)
Max. Pipe Height Difference Between Outdoor Unit & Branch Box Ft (m)	98 (30)
Max. Pipe Height Difference Between Indoor Units Ft (m)	49 (15)
Max. Pipe Height Difference Between Outdoor Unit & Farthest Indoor Ft (m)	98 (30)
Connection Method	Flare
Conn. Pipe Diameter Inch	3/8 (Liq.) 5/8 (Suc.)
Net Weight lbs. (kg)	216 (98)
Dimensions: Height Inch	36
mm	914
Width Inch	38-1/4
mm	970
Depth Inch	14-5/8
mm	370
Refrigerant	R410A

37\*Ducted / Non-Ducted / Mixed

	SEER	HSPF	EER**
<b>Ducted</b>	14.7	9.3	8.7
<b>Non-Ducted</b>	17.0	9.8	9.25
<b>Mixed</b>	15.8	9.5	8.97

\*\*Cooling

# Branch Boxes

## UTP-PU03A, UTP-PU03B



	UTP-PU03A Primary	UTP-PU03B Secondary
Connectable Indoor Unit	1 ~ 3	1 ~ 3
Max. Combination BTU/h	62,000 Nom.*	62,000 Nom.*
Min. Combination BTU/h	7,000 Nom.*	7,000 Nom.*
Clg. Operating Range °F(°C)	25-115 (-5-46)	25-115 (-5-46)
Htg. Operating Range °F(°C)	5-75 (-15-24)	5-75 (-15-24)
%RH	80 or less	80 or less
Voltage/Frequency/Phase	208-230/60/1	208-230/60/1
Maximum Current Ampacity (A)	15	15
Running Current <i>Rated</i> (A): Cooling	0.050	0.050
Heating	0.050	0.050
Power Use <i>Rated</i> (W): Cooling	10	10
Heating	10	10

\*As long as the total system nominal capacity is between 39,000 and 62,000 BTUs.

	UTP-PU03A Primary	UTP-PU03B Secondary
Dimensions: Gross (Flare to Flare):		
Height x Width x Depth <i>Inch</i>	7-5/8 x 33 x 14-5/8	7-5/8 x 33 x 14-5/8
Height x Width x Depth <i>mm</i>	195 x 838 x 370	195 x 838 x 370
Dimensions: Net (Metal Box Only):		
Height x Width x Depth <i>Inch</i>	7-5/8 x 17 x 14-5/8	7-5/8 x 17 x 14-5/8
Height x Width x Depth <i>mm</i>	195 x 433 x 370	195 x 433 x 370
Net Weight <i>lbs. (kg)</i>	20 (9)	20 (9)
Conn. Pipe Diameter - Main <i>Inch</i>	(3/8 Liq. x 5/8 Suc.)	(3/8 Liq. x 5/8 Suc.)
Conn. Pipe Diameter - Branch <i>Inch</i>	(1/4 Liq. x 1/2 Suc.)	(1/4 Liq. x 1/2 Suc.)
Connection Method	Flare	Flare
Connection Adapter Included <i>Inch</i>	(1/2MF x 3/8FF) x 3 No adapter needed for 18k BTU	(1/2MF x 3/8FF) x 3 No adapter needed for 18k BTU

**Warning:** Branch boxes are not weather tight enclosures and cannot be mounted outdoors or in damp environments exceeding 80% relative humidity, unless using the Branch Box Outdoor Enclosure, Part #UTP-PX-A. See Page 39 for more information.

### Allowed Branch Box Mounting Direction

#### Threaded Rod Mount



By reversing the electrical box position you can orient the inlet and outlet pipes into a left hand or right hand configuration.

#### Horizontal Wall Mount



By reversing the electrical box position you can orient the inlet and outlet pipes into a left hand or right hand configuration.

#### Vertical Wall Mount



You cannot reverse the electrical box position when mounting the branch box vertically.

## Branch Box Outdoor Enclosure

### UTP-PX-A

The Branch Box Outdoor Enclosure is used to mount the indoor style Branch Box outdoors. The Branch Box Outdoor Enclosure is a painted metal cover to match the condensing unit. When Branch Box Outdoor Enclosure is not required, see Installation Manual for indoor mounting instructions.

#### Allowed Mounting Positions

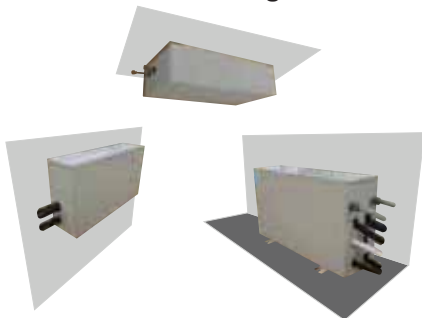

Dimensions in. (mm)	
Net (HxWxD)	8-11/16 x 32 x 17-7/8 (220 x 813 x 454)
Gross (HxWxD)	3-15/16 x 33-11/16 x 20-5/16 (100 x 880 x 515)
Weight lbs. (kg)	
Net Branch Box cover only	22 (10)
Net Branch Box + Cover	44.1(20)
Gross	30.9 (14)



## Separation Tube Assembly Kit

### UTP-SX248A

Size	Liquid <i>Inch</i>	Suction <i>Inch</i>
	3/8 x 3/8 x 3/8	5/8 x 5/8 x 5/8

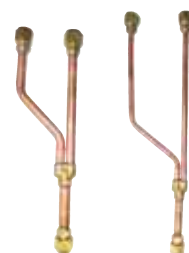



# Wiring

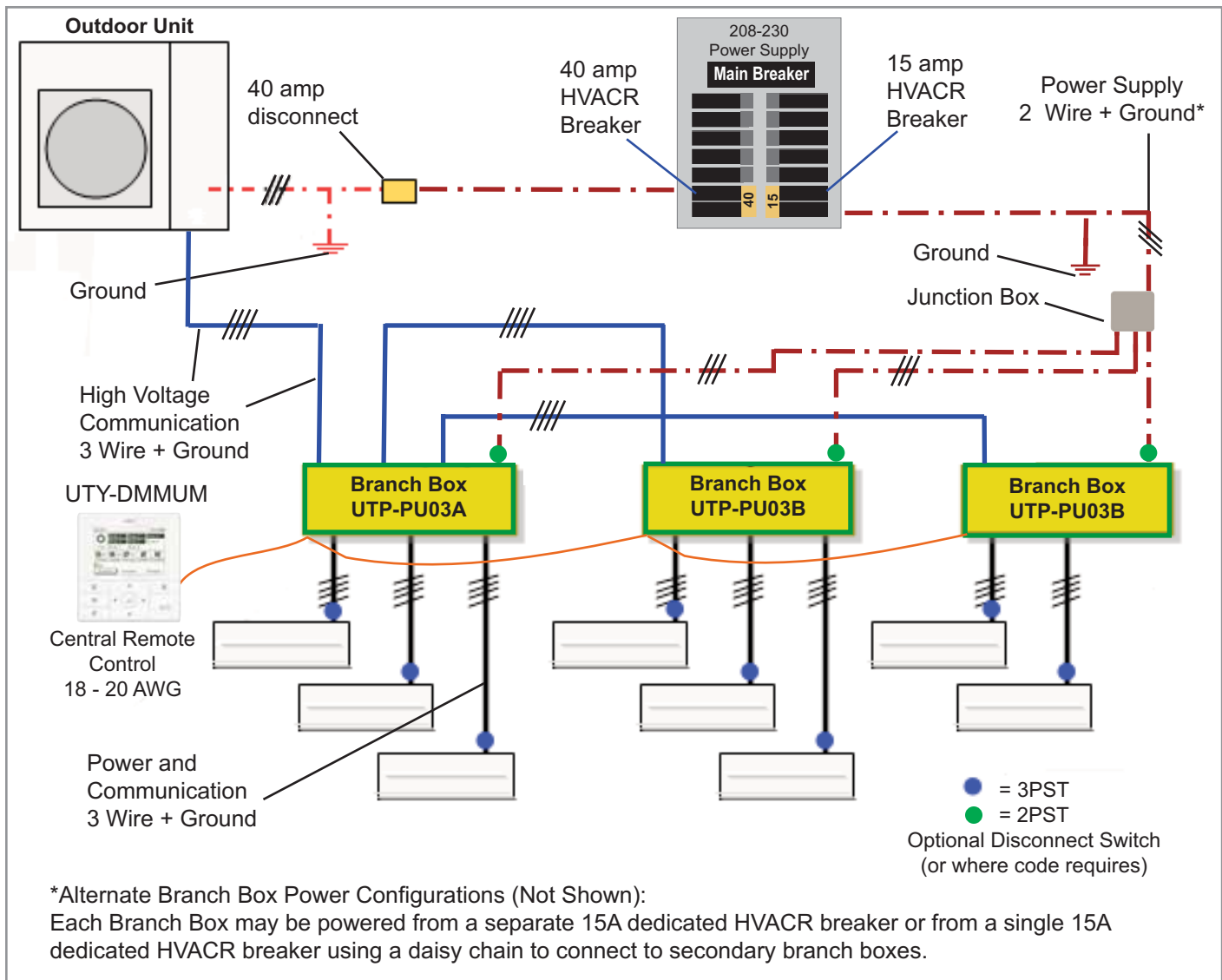

## Branch Box Terminal Connections

### Miswiring Detection

Errors Detected For...

- Miswired terminals
- Incorrect indoor unit
- Less than 2 or more than 8 indoor units
- Less than 39,000 or more than 62,000 BTUs

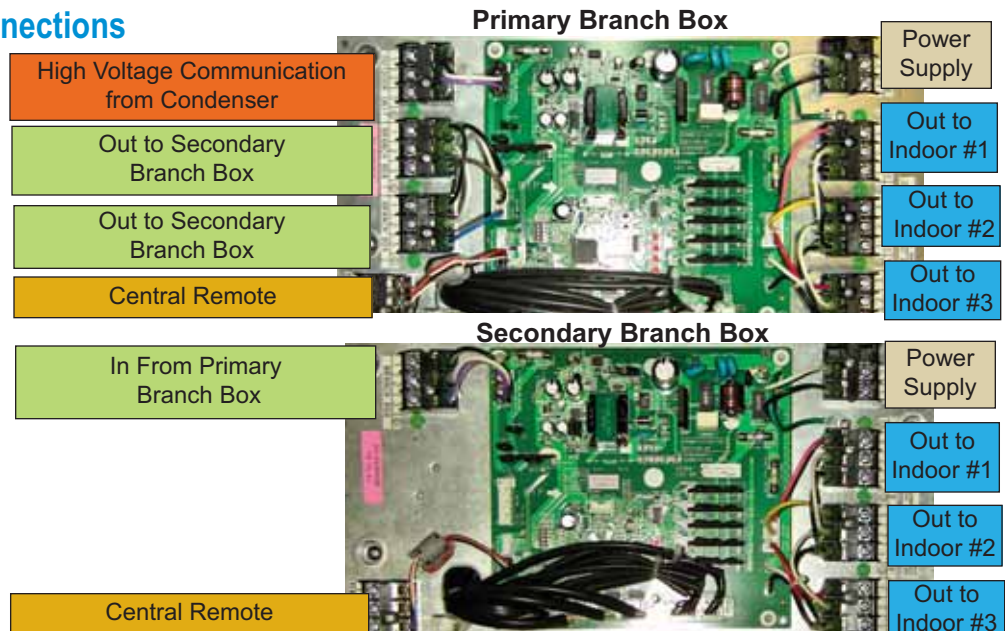

# Piping

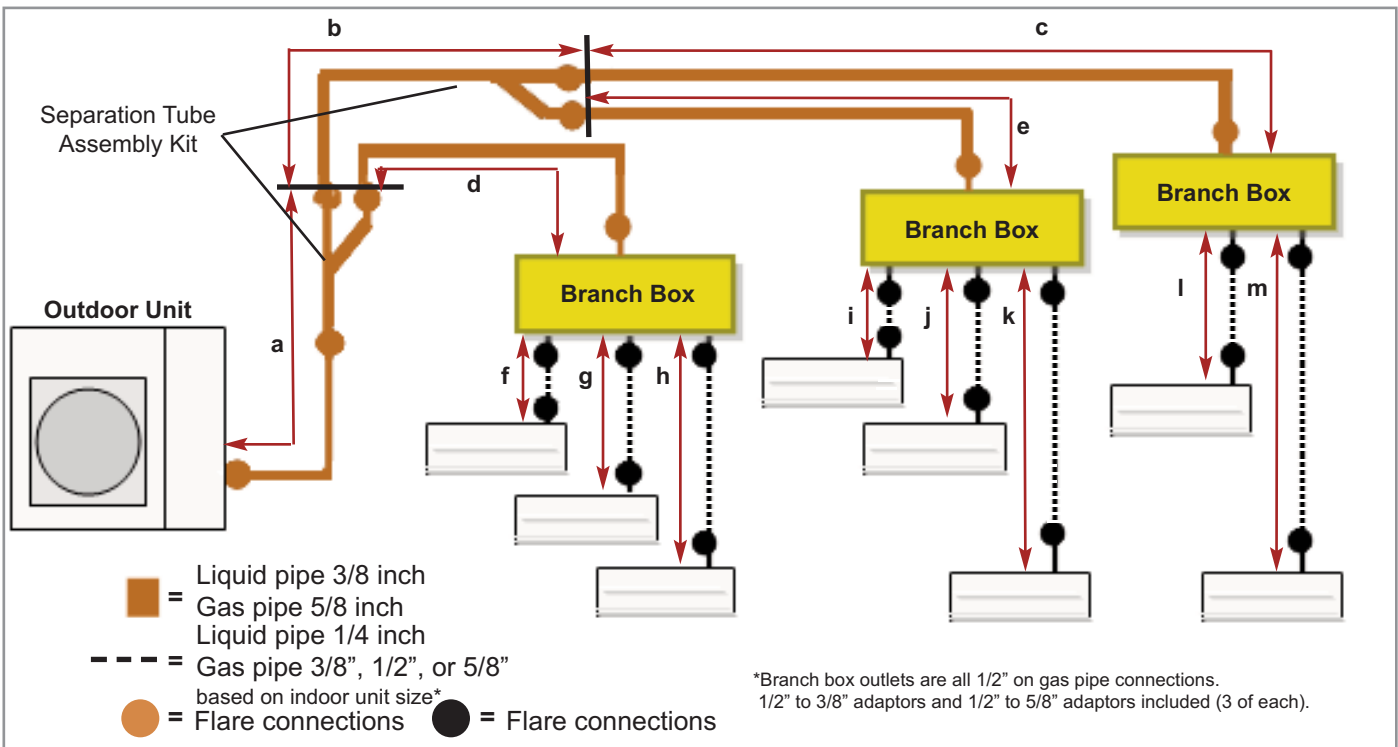

		Liquid pipe	Adaptor	Gas pipe
Branch Box to Indoor	7,000 BTU	1/4 inch	included	3/8 inch
	9,000 BTU		included	
	12,000 BTU		included	
	18,000 BTU		n/a	
	24,000 BTU		included	
Calculate Refrigerant Charge Factory Charge 7.6 lb (3.45 kg) Unit pre-charged to 0 feet	Pipe Diameter	Location		Additional Refrig.
	3/8"	Outdoor to Branch Box		0.624 oz./ft. or 58g/meter
	1/4"	Branch Box to Indoor Unit		0.224 oz./ft. or 21g/meter
(Total length of 3/8" liquid line × 0.624 oz./ft. or 58g/meter) + (Total length of 1/4" liquid line × 0.224 oz./ft. or 21g/meter) + (a+b+c+d+e) × 0.624 oz./ft. or 58g/meter + (f+g+h+i+j+k+l+m) × 0.224 oz./ft. or 21g/meter = additional refrigerant				

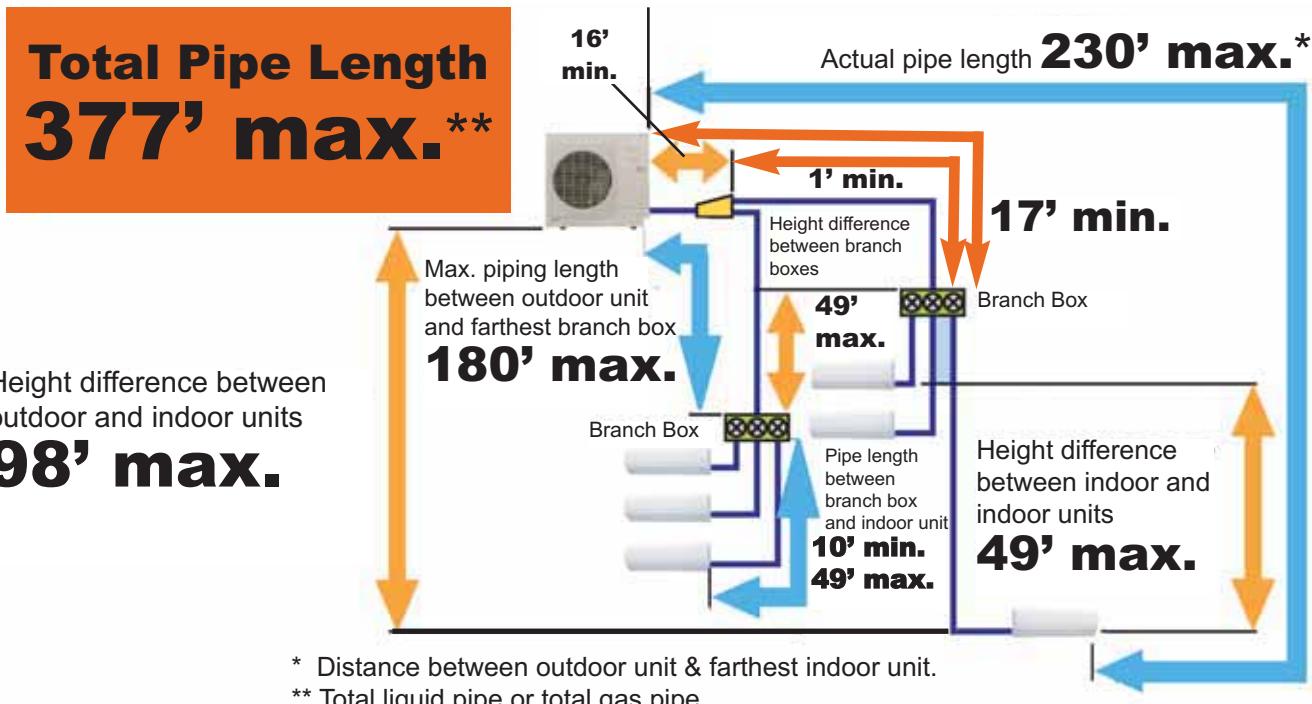

\* Distance between outdoor unit & farthest indoor unit.  
 \*\* Total liquid pipe or total gas pipe.



# Allowable Combinations for AOU48RLXFZ1

259 Combinations Based on BTU  
56,259 Combinations Based on Indoor Type and BTU



ASU7RLF1, ASU9RLF1,  
ASU9RLS2, ASU12RLF1,  
ASU12RLS2, ASU15RLS2,  
ASU18RLF, ASU24RLF



ARU7RLF, ARU9RLF,  
ARU12RLF, ARU18RLF,  
ARU24RLF



AUU7RLF  
AUU9RLF  
AUU12RLF  
AUU18RLF



AGU9RLF  
AGU12RLF  
AGU15RLF



AOU48RLXFZ1

= Allowed "Connectable Capacity" combinations between 100 and 130%

Indoor Units	BTU Values	Total BTU
4 INDOOR UNITS	15 15 15 18	60
	7 7 7 7 12	40
	7 7 7 7 15	42
	7 7 7 7 18	46
	7 7 7 7 24	52
	7 7 7 9 9	39
	7 7 7 9 12	42
	7 7 7 9 15	44
	7 7 7 9 18	48
	7 7 7 9 24	54
	7 7 7 12 12	45
	7 7 7 12 15	47
	7 7 7 12 18	51
	7 7 7 12 24	57
	7 7 7 15 15	49
	7 7 7 15 18	53
	7 7 7 15 24	59
	7 7 7 18 18	57
	7 7 9 9 9	41
	7 7 9 9 12	44
7 7 9 9 15	46	
7 7 9 9 18	50	
7 7 9 9 24	56	
7 7 9 12 12	47	
7 7 9 12 15	49	
7 7 9 12 18	53	
7 7 9 12 24	59	
7 7 9 15 15	51	
7 7 9 15 18	55	
7 7 9 15 24	61	
7 7 9 18 18	59	
7 7 12 12 12	50	
7 7 12 12 15	52	
7 7 12 12 18	56	
7 7 12 12 24	62	
7 7 12 15 15	54	
7 7 12 15 18	58	
7 7 12 15 24	64	
7 7 12 18 18	62	
7 7 15 15 15	56	
7 7 15 15 18	60	
7 9 9 9 9	43	
5 INDOOR UNITS	7 9 9 9 12	46
	7 9 9 9 15	48
	7 9 9 9 18	52
	7 9 9 9 24	58
	7 9 9 12 12	49
	7 9 9 12 15	51
	7 9 9 12 18	55
	7 9 9 12 24	61
	7 9 9 15 15	53
	7 9 9 15 18	57
	7 9 9 18 18	61
	7 9 12 12 12	52
	7 9 12 12 15	54
	7 9 12 12 18	58
	7 9 12 15 15	56
	7 9 12 15 18	60
	7 9 15 15 15	58
	7 9 15 15 18	62
	7 12 12 12 12	55
	7 12 12 12 15	57
7 12 12 12 18	61	
7 12 12 15 15	59	
7 12 15 15 15	61	
9 9 9 9 9	45	
9 9 9 9 12	48	
9 9 9 9 15	50	
9 9 9 9 18	54	
9 9 9 9 24	60	
9 9 9 12 12	51	
9 9 9 12 15	53	
9 9 9 12 18	57	
9 9 9 15 15	55	
9 9 9 15 18	59	
9 9 9 18 18	63	
9 9 12 12 12	54	
9 9 12 12 15	56	
9 9 12 12 18	60	
9 9 12 15 15	58	
9 9 12 15 18	62	
9 9 15 15 15	60	
9 12 12 12 12	57	
9 12 12 12 15	59	
9 12 12 15 15	61	
5 INDOOR UNITS	12 12 12 12 12	60
	12 12 12 12 15	62
	7 7 7 7 7 7	42
	7 7 7 7 7 9	44
	7 7 7 7 7 12	47
	7 7 7 7 7 15	49
	7 7 7 7 7 18	53
	7 7 7 7 7 24	59
	7 7 7 7 9 9	46
	7 7 7 7 9 12	49
	7 7 7 7 9 15	51
	7 7 7 7 9 18	55
7 7 7 7 9 24	61	
7 7 7 7 12 12	52	
7 7 7 7 12 15	54	
7 7 7 7 12 18	58	
7 7 7 7 12 24	64	
7 7 7 7 15 15	56	
7 7 7 7 15 18	60	
7 7 7 7 15 24	66	
7 7 7 9 9 9	48	
7 7 7 9 9 12	51	
7 7 7 9 9 15	53	
7 7 7 9 9 18	57	
7 7 7 9 12 12	54	
7 7 7 9 12 15	56	
7 7 7 9 12 18	60	
7 7 7 9 15 15	58	
7 7 7 9 15 18	62	
7 7 7 12 12 12	57	
7 7 7 12 12 15	59	
7 7 7 12 15 15	61	
7 7 9 9 9 9	50	
7 7 9 9 9 12	53	
7 7 9 9 9 15	55	
7 7 9 9 9 18	59	
7 7 9 9 9 24	65	
7 7 9 12 12 12	57	
7 7 9 12 12 15	59	
7 7 9 12 15 15	61	
7 7 9 12 18 18	65	
7 7 9 15 15 15	63	
7 7 9 15 15 18	67	
7 7 9 15 15 24	73	
7 7 9 18 18 18	71	
7 7 9 18 18 24	75	
7 7 9 24 24 24	81	
6 INDOOR UNITS	7 7 12 12 12 12	62
	7 9 9 9 9 9	52
	7 9 9 9 9 12	55
	7 9 9 9 9 15	57
	7 9 9 9 9 18	61
	7 9 9 9 9 24	67
	7 9 9 12 12 12	58
	7 9 9 12 12 15	60
	7 9 9 12 12 18	64
	7 9 9 12 12 24	70
	7 9 9 15 15 15	62
	7 9 9 15 15 18	66
7 9 9 15 15 24	72	
7 9 9 18 18 18	70	
7 9 9 18 18 24	74	
7 9 9 24 24 24	80	
9 9 9 9 9 9	54	
9 9 9 9 9 12	57	
9 9 9 9 9 15	59	
9 9 9 9 9 18	63	
9 9 9 9 9 24	69	
9 9 9 12 12 12	60	
9 9 9 12 12 15	62	
9 9 9 12 12 18	66	
9 9 9 12 12 24	72	
9 9 9 15 15 15	64	
9 9 9 15 15 18	68	
9 9 9 15 15 24	74	
9 9 9 18 18 18	72	
9 9 9 18 18 24	76	
9 9 9 24 24 24	82	
6 INDOOR UNITS	12 12 12 12 12 12	60
	12 12 12 12 12 15	62
	7 7 7 7 7 7 7	42
	7 7 7 7 7 7 9	44
	7 7 7 7 7 7 12	47
	7 7 7 7 7 7 15	49
	7 7 7 7 7 7 18	53
	7 7 7 7 7 7 24	59
	7 7 7 7 7 9 9	46
	7 7 7 7 7 9 12	49
	7 7 7 7 7 9 15	51
	7 7 7 7 7 9 18	55
7 7 7 7 7 9 24	61	
7 7 7 7 7 12 12	52	
7 7 7 7 7 12 15	54	
7 7 7 7 7 12 18	58	
7 7 7 7 7 12 24	64	
7 7 7 7 7 15 15	56	
7 7 7 7 7 15 18	60	
7 7 7 7 7 15 24	66	
7 7 7 7 9 9 9	48	
7 7 7 7 9 9 12	51	
7 7 7 7 9 9 15	53	
7 7 7 7 9 9 18	57	
7 7 7 7 9 12 12	54	
7 7 7 7 9 12 15	56	
7 7 7 7 9 12 18	60	
7 7 7 7 9 15 15	58	
7 7 7 7 9 15 18	62	
7 7 7 7 12 12 12	57	
7 7 7 7 12 12 15	59	
7 7 7 7 12 15 15	61	
7 7 7 9 9 9 9	50	
7 7 7 9 9 9 12	53	
7 7 7 9 9 9 15	55	
7 7 7 9 9 9 18	59	
7 7 7 9 9 12 12	57	
7 7 7 9 9 12 15	59	
7 7 7 9 9 12 18	63	
7 7 7 9 9 15 15	61	
7 7 9 9 9 9 9	50	
7 7 9 9 9 9 12	53	
7 7 9 9 9 9 15	55	
7 7 9 9 9 9 18	59	
7 7 9 9 9 12 12	57	
7 7 9 9 9 12 15	59	
7 7 9 9 9 12 18	63	
7 7 9 9 9 15 15	61	
7 7 9 12 12 12	59	
7 7 9 12 12 15	61	
7 7 9 12 15 15	63	
7 7 9 15 15 15	65	
7 9 9 9 9 9 9	61	
7 INDOOR UNITS	7 7 7 12 12 12 12	49
	7 7 7 7 7 7 7 7	42
	7 7 7 7 7 7 7 9	44
	7 7 7 7 7 7 7 12	47
	7 7 7 7 7 7 7 15	49
	7 7 7 7 7 7 7 18	53
	7 7 7 7 7 7 7 24	59
	7 7 7 7 7 9 9 9	46
	7 7 7 7 7 9 9 12	49
	7 7 7 7 7 9 9 15	51
	7 7 7 7 7 9 9 18	55
	7 7 7 7 7 9 12 12	52
7 7 7 7 7 9 12 15	54	
7 7 7 7 7 9 12 18	58	
7 7 7 7 7 9 12 24	64	
7 7 7 7 7 9 15 15	56	
7 7 7 7 7 9 15 18	60	
7 7 7 7 7 9 15 24	66	
7 7 7 7 9 9 9 9	48	
7 7 7 7 9 9 9 12	51	
7 7 7 7 9 9 9 15	53	
7 7 7 7 9 9 9 18	57	
7 7 7 7 9 12 12 12	54	
7 7 7 7 9 12 12 15	56	
7 7 7 7 9 12 12 18	60	
7 7 7 7 9 15 15 15	58	
7 7 7 7 9 15 15 18	62	
7 7 7 7 9 15 15 24	68	
7 7 7 9 9 9 9 9	50	
7 7 7 9 9 9 9 12	53	
7 7 7 9 9 9 9 15	55	
7 7 7 9 9 9 9 18	59	
7 7 7 9 9 12 12 12	57	
7 7 7 9 9 12 12 15	59	
7 7 7 9 9 12 12 18	63	
7 7 7 9 9 15 15 15	61	
7 7 7 9 9 15 15 18	65	
7 7 7 9 9 15 15 24	71	
7 7 9 9 9 9 9 9	50	
7 7 9 9 9 9 9 12	53	
7 7 9 9 9 9 9 15	55	
7 7 9 9 9 9 9 18	59	
7 7 9 9 9 12 12 12	57	
7 7 9 9 9 12 12 15	59	
7 7 9 9 9 12 12 18	63	
7 7 9 9 9 15 15 15	61	
7 7 9 9 9 15 15 18	65	
7 7 9 9 9 15 15 24	71	
7 9 9 9 9 9 9 9	61	
8 INDOOR UNITS	7 7 7 7 7 7 7 7 7	56
	7 7 7 7 7 7 7 7 9	58
	7 7 7 7 7 7 7 7 12	61
	7 7 7 7 7 7 7 7 15	63
	7 7 7 7 7 7 7 7 18	67
	7 7 7 7 7 7 7 7 24	73
	7 7 7 7 7 9 9 9 9	56
	7 7 7 7 7 9 9 9 12	59
	7 7 7 7 7 9 9 9 15	61
	7 7 7 7 7 9 9 9 18	65
	7 7 7 7 7 9 12 12 12	63
	7 7 7 7 7 9 12 12 15	65
7 7 7 7 7 9 12 12 18	69	
7 7 7 7 7 9 12 12 24	75	
7 7 7 7 7 9 15 15 15	67	
7 7 7 7 7 9 15 15 18	71	
7 7 7 7 7 9 15 15 24	77	
7 7 7 7 9 9 9 9 9	56	
7 7 7 7 9 9 9 9 12	59	
7 7 7 7 9 9 9 9 15	61	
7 7 7 7 9 9 9 9 18	65	
7 7 7 7 9 12 12 12 12	63	
7 7 7 7 9 12 12 12 15	65	
7 7 7 7 9 12 12 12 18	69	
7 7 7 7 9 12 12 12 24	75	
7 7 7 7 9 15 15 15 15	67	
7 7 7 7 9 15 15 15 18	71	
7 7 7 7 9 15 15 15 24	77	
7 7 9 9 9 9 9 9 9	56	
7 7 9 9 9 9 9 9 12	59	
7 7 9 9 9 9 9 9 15	61	
7 7 9 9 9 9 9 9 18	65	
7 7 9 9 9 12 12 12 12	63	
7 7 9 9 9 12 12 12 15	65	
7 7 9 9 9 12 12 12 18	69	
7 7 9 9 9 12 12 12 24	75	
7 7 9 9 9 15 15 15 15	67	
7 7 9 9 9 15 15 15 18	71	
7 7 9 9 9 15 15 15 24	77	
7 9 9 9 9 9 9 9 9	61	

## Remote Controls

### Wired Remote Controller\*

UTY-RNBYU<sup>^</sup>/UTY-RNNUM<sup>^</sup>



The wired remote controller with its unique lock function and sleek design provides full feature access to property managers, building owners, and facility maintenance, as well as providing basic comfort features to tenants, employees, and teachers.

### Wired Remote Controller

UTY-RVNUM



Features a large backlit LCD display and displays the room temperature. Provides full feature access to property managers, building owners, and facility maintenance, as well as providing basic comfort features to tenants, employees, and teachers.

### Simple Remote Controller

UTY-RSNUM\*



Suitable when only basic operations are required for hotels, offices and other places where there is frequent arrival and departure of occupants. Remote does not allow any timer settings.

### Wireless Remote Controller

UTY-LNHUM



For spaces where there is just no place to mount the wired remote or where wireless operation is preferred.

### Central Remote Controller

UTY-DMMUM



This remote controls up to 8 individual indoor units. Set temperatures on timers to best meet individuals' needs. Includes a large backlit LCD and 4-way navigation pad. Remote connects in daisy chain to branch boxes. *Used with AOU48RLXFZ1 only.*

### Remote Sensor

UTY-XSZX



Wall mounted room temperature sensor for slim duct models. Replaces room temperature sensor in the return when installed while still allowing for temperature correction.

### Receiver Unit

UTY-LRNUM



For slim duct models. Includes a wireless remote control.

## Interface Kits

### Dry Contact Wire Kit\*

UTY-XWZX/UTY-XWZXZ5



Turns system on or off using a normally open circuit. For example in home automation, BMS integration of only On/Off operation, occupancy sensor, key card switch, or lead-lag control of other heating/cooling devices.

### Interface Kit

UTY-XCBXZ2\*\*



Required to connect ASU7RLF1, 9RLF1, and 12RLF1 to Wired Remote UTY-RNNUM, Dry Contact Wire Kit UTY-XWZX, and Simple Remote Control UTY-RSNUM.

### Interface Kit

UTY-TWBXF1\*\*



Required to connect the ASU9RLS2, ASU12RLS2 and ASU15RLS2 to Wired Remotes UTY-RNNUM and UTY-RVNUM, Dry Contact Wire Kit UTY-XWZXZ5, and Simple Remote Control UTY-RSNUM.

### Slim Duct Connector Kit

UTD-ECS5A



Comes with 5 sets of wires. Can be used to turn unit on/off, wire in float switch, AUX heater, turn on an external device (Fan), or show if the unit is running.

### Outdoor Unit Input/Output Connector

UTY-XWZXZ3



Gives the ability to limit the noise of the unit\*, stop the outdoor unit, limit power consumption\*, control the operating mode (Htg/Clg), or use output status to see if the compressor is running. You will need to order a kit for each option.

\*Will reduce capacity.

### Outdoor Unit Base Heater Connector

UTY-XWZXZ4



Used to hook up an AUX base pan heater to the outdoor unit. Heater will stop ice from forming in the outdoor unit. Base heater will operate when outdoor temperature is below 36°F. Heater is field supply. Heaters greater than 25W can't be fed directly from the board, but have to be powered from another source.

## Fresh Air Intake Kits

### High Humidity Insulation Kit

UTZ-KXGC



Additional insulation for compact cassette units, which may be needed when they are installed in high humidity areas.

### Air Outlet Shutter Plate

UTR-YDZB



In a 3-way air flow configuration an Air Outlet Shutter Plate kit is required to block air flow of 1 louver.

### Fresh Air Intake Kit

UTZ-VXAA



Mixes room air then passes it through a heat exchanger. Allows for a 4-inch flex duct connection. Requires a field supplied duct booster fan capable of 60 CFM at .2"W.C. or 90 CFM at .4"W.C. For fan static pressure requirements, see installation manual.

### Fresh Air Intake Kit

KHRS940-25

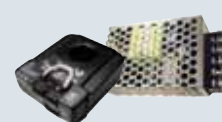

Kit contains current sensor with built-in relay (Split Core Fixed Threshold Current Status Sensor with Command Relay) and Switching Power Supply. Duct and Fan are field supply. A fan capable of generating 15 CFM at a static pressure of approximately .26 inches W.C. required.

<sup>^</sup> Minimum Heat, Sleep Timer functions will be lost when the wired remote controller is installed.

\* Wall mounted ASU7, 9, and 12RLF1 require accessory interface kit (Part UTY-XCBXZ2) in order to connect this device to them. Wall mounted ASU9, 12, and 15RLS2 require accessory interface kit (Part UTY-TWBXF1) in order to connect this device to them.

\*\* Internal thermosensor function in Wired Remote UTY-RNNUM is disabled when using this interface kit.





## Line Set Sizes and Lengths

		Single Zone Systems																																						
		9RL2	9RLFF	9RLFFH	9RLFW	9RLS2	9RLS2H	12RL2	12RLFF	12RLFFH	12RLFW	12RLS2	12RLS2H	15RLFF	15RLFFH	15RLS2	15RLS2H	18CL	18RLXFW	24RLXFW	24CL1	30CLX1	30RLX	36CLX1	9RLFCD	12RLFCD	18RLFCD	9RLFCC	12RLFCC	18RLFCC	18RULX	24RULX	36RSLX	18RCLX	24RCLX	36RCLX	42RCLX			
1/4" x 3/8"		●	●	●	●	●	●	●	●	●	●	●	●	●	●	●	●	●								●														
1/4" x 1/2"														●	●	●	●	●																				●		
1/4" x 5/8"																					●																			
3/8" x 1/2"																																								
3/8" x 5/8"																				●	●																	●	●	
<b>Total System</b>																																								
Max. Combined	Pipe Length ft (m)	66 (20)	66 (20)	66 (20)	66 (20)	66 (20)	66 (20)	66 (20)	66 (20)	66 (20)	66 (20)	66 (20)	66 (20)	66 (20)	66 (20)	66 (20)	66 (20)	66 (20)	165 (50)	165 (50)	66 (20)	165 (50)	165 (50)	165 (50)	66 (20)	66 (20)	66 (20)	66 (20)	66 (20)	66 (20)	165 (50)	165 (50)	165 (50)	165 (50)	165 (50)	165 (50)	230 (70)			
Min. Combined	Pipe Length ft (m)	10 (3)	10 (3)	10 (3)	10 (3)	10 (3)	10 (3)	10 (3)	10 (3)	10 (3)	10 (3)	10 (3)	10 (3)	10 (3)	10 (3)	10 (3)	10 (3)	10 (3)	16 (5)	16 (5)	10 (3)	16 (5)	16 (5)	16 (5)	10 (3)	10 (3)	10 (3)	10 (3)	10 (3)	10 (3)	16 (5)	16 (5)	16 (5)	16 (5)	16 (5)	16 (5)	16 (5)			

While these systems share indoor units, different line sizes are required.

		Multi / Flex Zone Models																																				
		ASU7RLF	ASU9RLF	ASU9RLS2	ASU12RLF	ASU12RLS2	ASU15RLS2	ASU18RLF	ASU24RLF	AGU9RLF	AGU12RLF	AGU15RLF	ARU7RLF	ARU9RLF	ARU12RLF	ARU18RLF	ARU24RLF	AUU7RLF	AUU9RLF	AUU12RLF	AUU18RLF	ASU18RLF x 2*	AGU18RLF x 2*	2*ARU18RLF x 2*	AUU18RLF x 2*	UTP-PU03A/3B <sup>^</sup>	AOU18RLXFZ	AOU24RLXFZ	AOU36RLXFZ	AOU36RLXFZ (18*18)	AOU48RLXFZ1							
1/4" x 3/8"		●	●	●	●	●	●	●	●	●	●	●	●	●	●	●	●	●	●	●	●	●	●	●	●	●												
1/4" x 1/2"						●	●	●	●																													
1/4" x 5/8"																																						
3/8" x 1/2"																																						
3/8" x 5/8"																																						
<b>Total System</b>																	165	165	230	131	377																	
Max. Combined	Pipe Length ft (m)																(50)	(50)	(70)	(40)	(115)																	
Min. Combined	Pipe Length ft (m)																49	49	66	49	16 <sup>1</sup>																	
	Pipe Length ft (m)																(15)	(15)	(20)	(15)	(5) <sup>2</sup> (3) <sup>2</sup>																	



\*18+18 is the only 2 indoor unit combination allowed for AOU36RLXFZ and requires kit K9FZ1818.

While these systems share indoor units, different line sizes are required.

<sup>^</sup> Line set size from outdoor unit AOU48RLXFZ1 to the branch boxes.

<sup>1</sup> Minimum combined pipe length from outdoor unit to branch box.

<sup>2</sup> Minimum combined pipe length from branch box to indoor unit each.

## Fujitsu Model Nomenclature

Model	48	R	L	X	F	Z
ASU	Wall Mount	R = Reverse cycle heat pump	C = Cassette	L = Inverter	S = Super Efficient	Z = Zone
ABU	Universal Mount Ceiling Suspended	C = Cooling only	S = Ceiling Suspended	X = Extended Line Set	X = Extended Line Set	W = Wall Mount Only
ARU	Slim Duct		L = Inverter	S = Super Efficient	F = HFI (when followed by a "W" or "Z") or Floor Mount	H = High Heating
AUU	Cassette Mount		U = Universal	F = HFI	H = High Heating	
AGU	Floor Mount				W = Wall Mount Only	
AOU	Outdoor Unit				C = Compact Cassette or Slim Duct	

\* 1 or 2 at end of model number denotes model revision. Please note models may not be combined with each other.

## Things To Know Before You Buy a Fujitsu System

### Complete System Warranty

Warranties vary depending on model:

2 Year Parts, 6 Year Compressor Warranty OR

5 Year Parts, 7 Year Compressor Warranty.

Note: Condensing units come pre-charged from factory. Additional refrigerant may be required, be sure to check installation manual for more details.



- Cooling capacity is based on the following conditions:
  - Indoor temperature: 80°F DB/67°F WB (26.7°C DB/19.4°C WB)
  - Outdoor temperature: 95°F DB/75°F WB (35°C DB/23.9°C WB)
- Heating capacity is based on the following conditions:
  - Indoor temperature: 70°F DB (21.1°C DB)
  - Outdoor temperature: 47°F DB/43°F WB (8.3°C DB/6.1°C WB)

### Trademarks

The Fujitsu logo is a registered trademark of Fujitsu Limited. The Halcyon and Halcyon HFI logos and names are trademarks of Fujitsu General America, Inc. ENERGY STAR® is a registered trademark of the EPA and DOE. Copyright © 2014 Fujitsu General America, Inc.

### Non-Internet Retail Policy

Internet sales are strictly prohibited and unauthorized. Any HVAC systems purchased on the Internet, from an online retailer or any similar e-tailing website, OR where the original factory serial numbers of the display have been removed, defaced, or replaced in any way WILL NOT BE COVERED BY WARRANTY.

## Things To Know Before You Install a Fujitsu System

### Warning

Always use a licensed installer or contractor to install this product. Do not try to install the product yourself. Improper installation can result in water or refrigerant leakage, electrical shock, fire or explosion. Use only parts and accessories supplied or specified by Fujitsu. Ask a licensed contractor to install parts and accessories. Use of unauthorized or improper installation of parts and accessories can result in injury or property damage. Read the owner's operation manual carefully before using this product. The owners operation manual provides important safety instructions and warnings which should be followed closely. For any questions or concerns, please contact Fujitsu General America, Inc. Proper sizing and installation of equipment is critical to achieve optimal performance. Split system air conditioners and heat pumps must be matched with appropriate coil components to meet ENERGY STAR criteria. Ask your contractor for details or visit [www.energystar.gov](http://www.energystar.gov).

### Heat Pump Disclaimer

In most climates a heat pump will handle all of your heating needs. However, this system sometimes requires some other additional source of heat to satisfy heating requirements in the coldest environments. Almost all of Fujitsu's heat pumps use inverter technology and as such offer a wider operating range and more heat capacity than a standard heat pump but will not provide adequate heating if improperly sized or operated outside of its operating range. Specifications vary by model; please consult your contractor before choosing a heat pump as your only source of heat. Systems will maintain temperature up to +/-4 degrees relative to set temperature. To increase energy efficiency on multi-type systems, you should turn off the evaporators when heating or cooling is not needed.

### Disclaimer

Fujitsu's products are subject to continuous improvements. Fujitsu reserves the right to modify product design, specifications and information in this brochure without notice and without incurring any obligations.

## Certifications

### ISO

ISO14001 is the standard defined by the International Organization for Standardization (ISO) related to environmental management systems. Fujitsu General America, Inc. has been acknowledged by an internationally accredited compliance organization as having an appropriate program of environmental protection procedures and activities to meet the requirements of ISO14001. The air conditioners manufactured by Fujitsu have received ISO9001 series certification for quality assurance.



• ISO9001 • ISO14001

Intertek

### AHRI Energy Guide® Program (U.S.)

To view AHRI numbers or Energy Guide labels, please go to [www.ahridirectory.org](http://www.ahridirectory.org).



### ASTM

Our outdoor units shall withstand 1,000 hours of salt spray tested per procedure ASTM B117.

### RoHS Compliant

Fujitsu participates in the RoHS Directive, which is the Restriction of Hazardous Substances in electrical and electronic equipment. It is an EU directive intended protect the environment by forcing manufacturers to eliminate or severely curtail the use of cadmium, hexavalent chromium, and lead in all products from automobiles to consumer electronics.



### HRAI EnerGuide® Program (Canada)

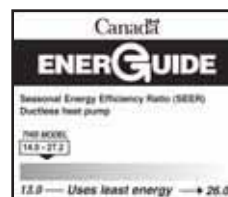
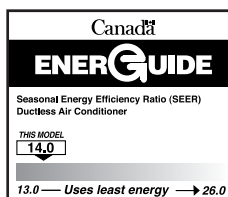

For over 35 years,  
making the hottest places cool  
and the coolest places...  
**more comfortable.**

**Halcyon Mini-Splits Are For You If:**

- If you want to reduce your utility bills by up to 25%
- Central air quotes give you sticker shock
- You don't want to lose closet space to ductwork
- You have warm or cold spots in your home or business
- Your window air conditioner's noise prevents you from hearing the television

**Halcyon** 



**Distributed by:**

**FUJITSU**

Fujitsu General America, Inc.  
353 Route 46 West  
Fairfield, NJ 07004  
Toll Free: (888) 888-3424  
Local: (973) 575-0380  
Fax: (973) 836-0447  
Email: [hvac@fujitsugeneral.com](mailto:hvac@fujitsugeneral.com)  
[www.fujitsugeneral.com](http://www.fujitsugeneral.com)

A subsidiary of  
Fujitsu General Limited

